



OWNER'S MANUAL

MINI MINI CONVERTIBLE



**COOPER
COOPER S
JOHN COOPER
WORKS**

Congratulations on your new MINI

This Owner's Manual should be considered a permanent part of this vehicle. It should stay with the vehicle when sold to provide the next owner with important operating, safety and maintenance information.

We wish you an enjoyable driving experience.

© 2010 Bayerische Motoren Werke
Aktiengesellschaft
Munich, Germany
Reprinting, including excerpts, only with the
written consent of BMW AG, Munich.
US English II/10
Printed on environmentally friendly paper,
bleached without chlorine, suitable for recycling.

CONTENTS

The fastest way to find information on a particular topic or item is by using the index, refer to page 160.

Using this Owner's Manual

- 4 Notes
- 6 Reporting safety defects

AT A GLANCE

- 10 Cockpit

CONTROLS

- 18 Opening and closing
- 35 Adjustments
- 41 Transporting children safely
- 44 Driving
- 53 Controls overview
- 63 Technology for driving comfort and safety
- 74 Lamps
- 79 Climate
- 84 Practical interior accessories

DRIVING TIPS

- 92 Things to remember when driving

MOBILITY

- 102 Refueling
- 104 Wheels and tires
- 116 Under the hood
- 119 Maintenance
- 121 Care
- 125 Replacing components
- 136 Giving and receiving assistance
- 140 Indicator and warning lamps

REFERENCE

- 154 Technical data
- 160 Everything from A to Z

NOTES

USING THIS OWNER'S MANUAL

We have tried to make all the information in this Owner's Manual easy to find. The fastest way to find specific topics is to refer to the detailed index at the back of the manual. If you wish to gain an initial overview of your vehicle, you will find this in the first chapter.

Should you wish to sell your MINI at some time in the future, remember to hand over this Owner's Manual to the new owner; it is an important part of the vehicle.

Additional sources of information

Should you have any other questions, your MINI dealer will be glad to advise you at any time.

You can find more information about the MINI, for example on its technology, on the Internet at www.MINI.com.

SYMBOLS USED

 Indicates precautions that must be followed precisely in order to avoid the possibility of personal injury and serious damage to the vehicle. ◀

 Indicates information that will assist you in gaining the optimum benefit from your vehicle and enable you to care more effectively for your vehicle. ◀

 Refers to measures that can be taken to help protect the environment. ◀

◀ Marks the end of a specific item of information.

* Indicates special equipment, country-specific equipment and optional accessories, as well as equipment and functions not yet available at the time of printing.

Symbols on vehicle components

 Indicates that you should consult the relevant section of this Owner's Manual for information on a particular part or assembly.

THE INDIVIDUAL VEHICLE

The manufacturer of your MINI is the Bayerische Motoren Werke Aktiengesellschaft, BMW AG.

When you ordered your MINI, you chose various items of equipment. This Owner's Manual describes the entire array of options and equipment that the manufacturer of your MINI makes available with a specific model range.

Bear in mind that the manual may contain information on accessories and equipment that you have not specified for your own vehicle. Sections describing options and special equipment are marked by asterisks * to assist you in identifying possible differences between the descriptions in this manual and your own vehicle's equipment.

If your MINI features equipment not described in this Owner's Manual, observe the enclosed Supplementary Owner's Manuals.

EDITORIAL NOTICE

The manufacturer pursues a policy of continuous, ongoing development that is conceived to ensure that MINI vehicles continue to embody the highest quality and safety standards combined with advanced, state-of-the-art technology. For this reason, it is possible in exceptional cases that features described in this Owner's Manual could differ from those on your vehicle.

FOR YOUR SAFETY

Maintenance and repair

 Advanced technology, e.g. the use of modern materials and powerful electronics, requires specially adapted maintenance and repair methods. Therefore, have the necessary work on your MINI only carried out by a MINI dealer or a workshop that has specially trained personnel working in accordance with the specifications of the MINI manufacturer. If this work is not carried out properly, there is a danger of subsequent damage and related safety hazards. ◀

Parts and accessories

 For your own safety, use genuine parts and accessories approved by the manufacturer of the MINI.

When you purchase accessories tested and approved by the manufacturer of the MINI and Original MINI Parts, you simultaneously acquire the assurance that they have been thoroughly tested by the manufacturer of the MINI to ensure optimum performance when installed on your vehicle.

The manufacturer of the MINI warrants these parts to be free from defects in material and workmanship.

The manufacturer of the MINI will not accept any liability for damage resulting from installation of parts and accessories not approved by the manufacturer of the MINI.

The manufacturer of the MINI cannot test every product made by other manufacturers to verify if it can be used on a MINI safely and without risk to either the vehicle, its operation, or its occupants.

Original MINI Parts, MINI Accessories and other products approved by the manufacturer of the MINI, together with professional advice on using these items, are available from all MINI dealers.

Installation and operation of accessories that have not been approved by the manufacturer of your MINI, such as alarms, radios, amplifiers, radar detectors, wheels, suspension compo-

nents, brake dust shields, telephones, including operation of any mobile phone from within the vehicle without using an externally mounted antenna, or transceiver equipment, for instance, CBs, walkie-talkies, ham radios or similar accessories, may cause extensive damage to the vehicle, compromise its safety, interfere with the vehicle's electrical system or affect the validity of the MINI Limited Warranty. See your MINI dealer for additional information. ◀

 Maintenance, replacement, or repair of the emission control devices and systems may be performed by any automotive repair establishment or individual using any certified automotive part. ◀

California Proposition 65 warning

California law requires us to issue the following warning:

 Engine exhaust and a wide variety of automobile components and parts, including components found in the interior furnishings in a vehicle, contain or emit chemicals known to the State of California to cause cancer and birth defects and reproductive harm. In addition, certain fluids contained in vehicles and certain products of component wear contain or emit chemicals known to the State of California to cause cancer and birth defects or other reproductive harm.

Battery posts, terminals and related accessories contain lead and lead compounds. Wash your hands after handling.

Used engine oil contains chemicals that have caused cancer in laboratory animals. Always protect your skin by washing thoroughly with soap and water. ◀

SERVICE AND WARRANTY

We recommend that you read this publication thoroughly.

Your MINI is covered by the following warranties:

- ▷ New Vehicle Limited Warranty
- ▷ Rust Perforation Limited Warranty

- ▷ Federal Emissions System Defect Warranty
- ▷ Federal Emissions Performance Warranty
- ▷ California Emission Control System Limited Warranty

Detailed information about these warranties is listed in the Service and Warranty Information Booklet for US models or in the Warranty and Service Guide Booklet for Canadian models.

Your vehicle has been specifically adapted and designed to meet the particular operating conditions and registration requirements in your country and continental region in order to deliver the full driving pleasure while the vehicle is operated under those conditions. If you wish to operate your vehicle in another country or region, you may be required to adapt your vehicle to meet different prevailing operating conditions and registration requirements. You should also be aware of any applicable warranty limitations or exclusions for such country or region. In such a case, please contact Customer Relations for further information.

REPORTING SAFETY DEFECTS

For US customers

The following applies only to vehicles owned and operated in the US.

If you believe that your vehicle has a defect that could cause a crash or could cause injury or death, you should immediately inform the National Highway Traffic Safety Administration, NHTSA, in addition to notifying MINI of North America, LLC, P.O. Box 1227, Westwood, New Jersey 07675-1227, Telephone 1-800-831-1117.

If NHTSA receives similar complaints, it may open an investigation, and if it finds that a safety defect exists in a group of vehicles, it may order a recall and remedy campaign. However, NHTSA cannot become involved in individual problems between you, your dealer, or MINI of North America, LLC.

To contact NHTSA, you may call the Vehicle Safety Hotline toll-free at 1-888-327-4236 (TTY: 1-800-424-9153); go to <http://www.safercar.gov>; or write to: Administrator, NHTSA, 400 Seventh Street, SW., Washington, DC 20590. You can also obtain other information about motor vehicle safety from <http://www.safercar.gov>

For Canadian customers

Canadian customers who wish to report a safety-related defect to Transport Canada, Defect Investigations and Recalls, may call 1-800-333-0510 toll-free from anywhere in Canada or 1-613-993-9851 from the Ottawa region and from other countries, or contact Transport Canada by mail at: transport Canada, ASFAD, Place de Ville, Tower C, 330 Sparks Street, Ottawa, ON, K1A 0N5.

You can also obtain other information about motor vehicle safety from <http://www.tc.gc.ca>



AT A GLANCE

CONTROLS

DRIVING TIPS

MOBILITY

REFERENCE

COCKPIT

AROUND THE STEERING WHEEL: CONTROLS AND DISPLAYS

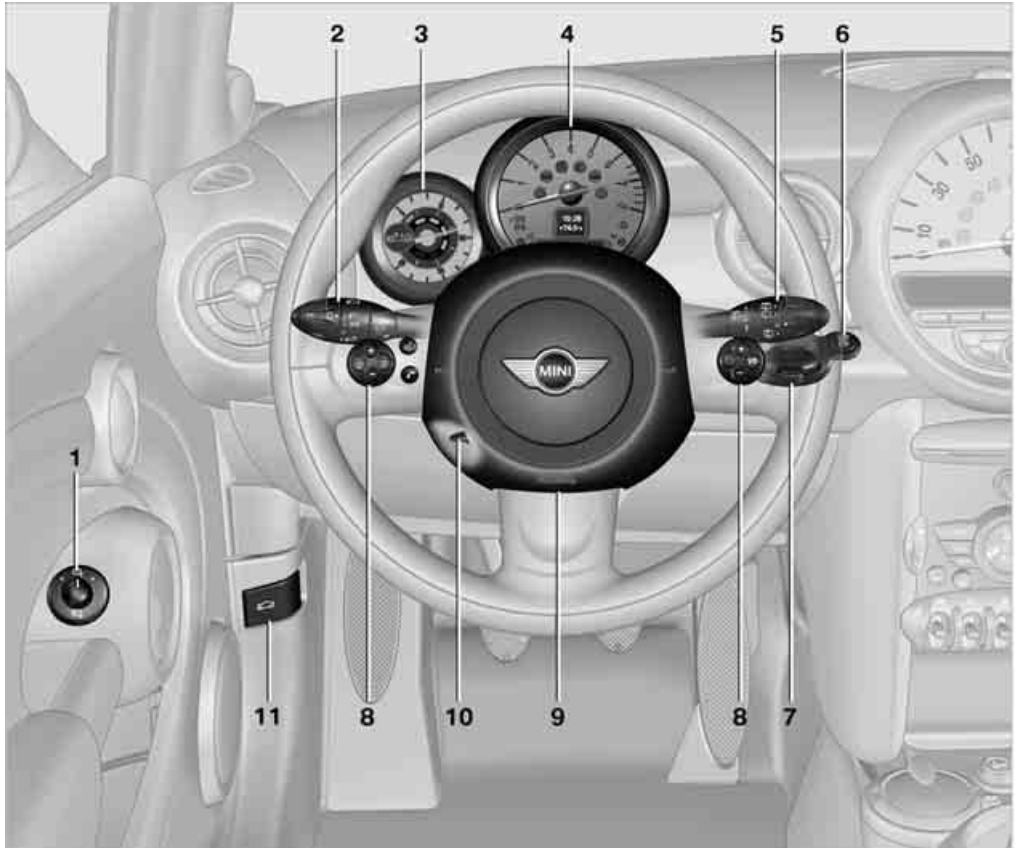



1 Adjusting the exterior mirrors, folding them in and out* 39

2  Parking lamps 74

 Low beams 74

 Automatic headlamp control* 74

 Turn signals 48

 High beams 76
 Headlamp flasher 48

 Roadside parking lamps* 76

 Computer* 54

3 Always Open Timer 55

4 Tachometer 12



Instrument lighting 77



Resetting the trip odometer 53

5  Wiper system 49

6  Switching the ignition on/off and starting/stopping the engine 44

7 Ignition lock 44

8 Buttons* on steering wheel



Continuing cruise control* 51



Right:
Storing speed and accelerating or decelerating



Left:
Increase or reduce volume



Activating/deactivating cruise control* 52



Telephone*:
Accepting and ending a call, starting dialing* of selected phone number and redialing if no phone number is selected



Activating/deactivating voice activation system*



Changing radio station
Selecting music track



Scrolling through phone book and lists with stored phone numbers

9 Horn: the entire surface

10 Adjusting the steering wheel 40

11 Releasing the hood 116

DISPLAYS

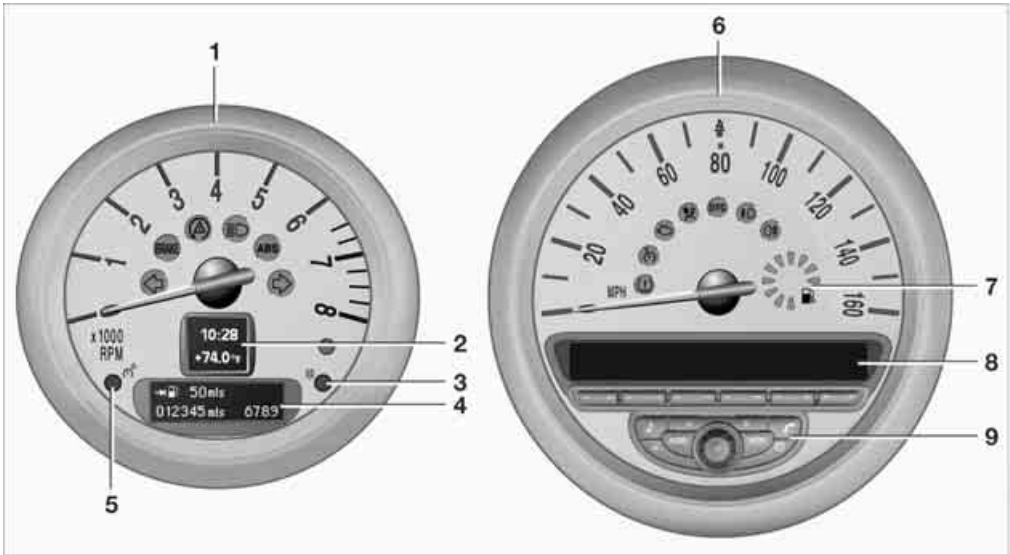

- 1 Tachometer [53](#)
with indicator and warning lamps [13](#)
- 2 Display for
 - ▷ Clock [53](#)
 - ▷ Outside temperature [53](#)
 - ▷ Current vehicle speed [53](#)
 - ▷ Indicator and warning lamps [13](#)
- 3 Resetting the trip odometer [53](#)
- 4 Display for
 - ▷ Position of automatic transmission* [46](#)
 - ▷ Computer* [54](#)
 - ▷ Date of next scheduled service, and remaining distance to be driven [58](#)
 - ▷ Odometer and trip odometer [53](#)
 - ▷ Initializing the Flat Tire Monitor* [66](#)
 - ▷ Resetting the Tire Pressure Monitor* [68](#)
 - ▷ Settings and information [56](#)
 - ▷ Personal Profile settings [18](#)
- 5 Instrument lighting [77](#)
- 6 Speedometer
with indicator and warning lamps [13](#)
- 7 Fuel gauge [54](#)
- 8 Radio display, refer to separate Owner's Manual
- 9 Radio, refer to separate Owner's Manual

INDICATOR AND WARNING LAMPS

The concept

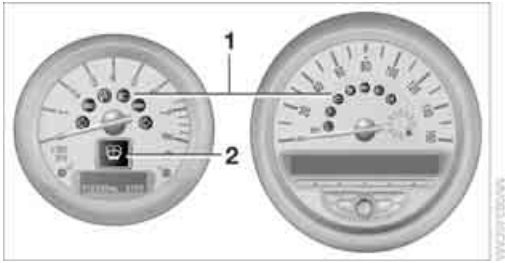

Indicator and warning lamps can light up in various combinations and colors in indicator area 1 or 2.

Some lamps are checked for proper functioning and thus come on briefly when the engine is started or the ignition is switched on.

What to do in case of a malfunction

A list of all indicator and warning lamps, as well as notes on possible causes of malfunctions and on how to respond, can be found starting on page 140.

AROUND THE CENTER CONSOLE

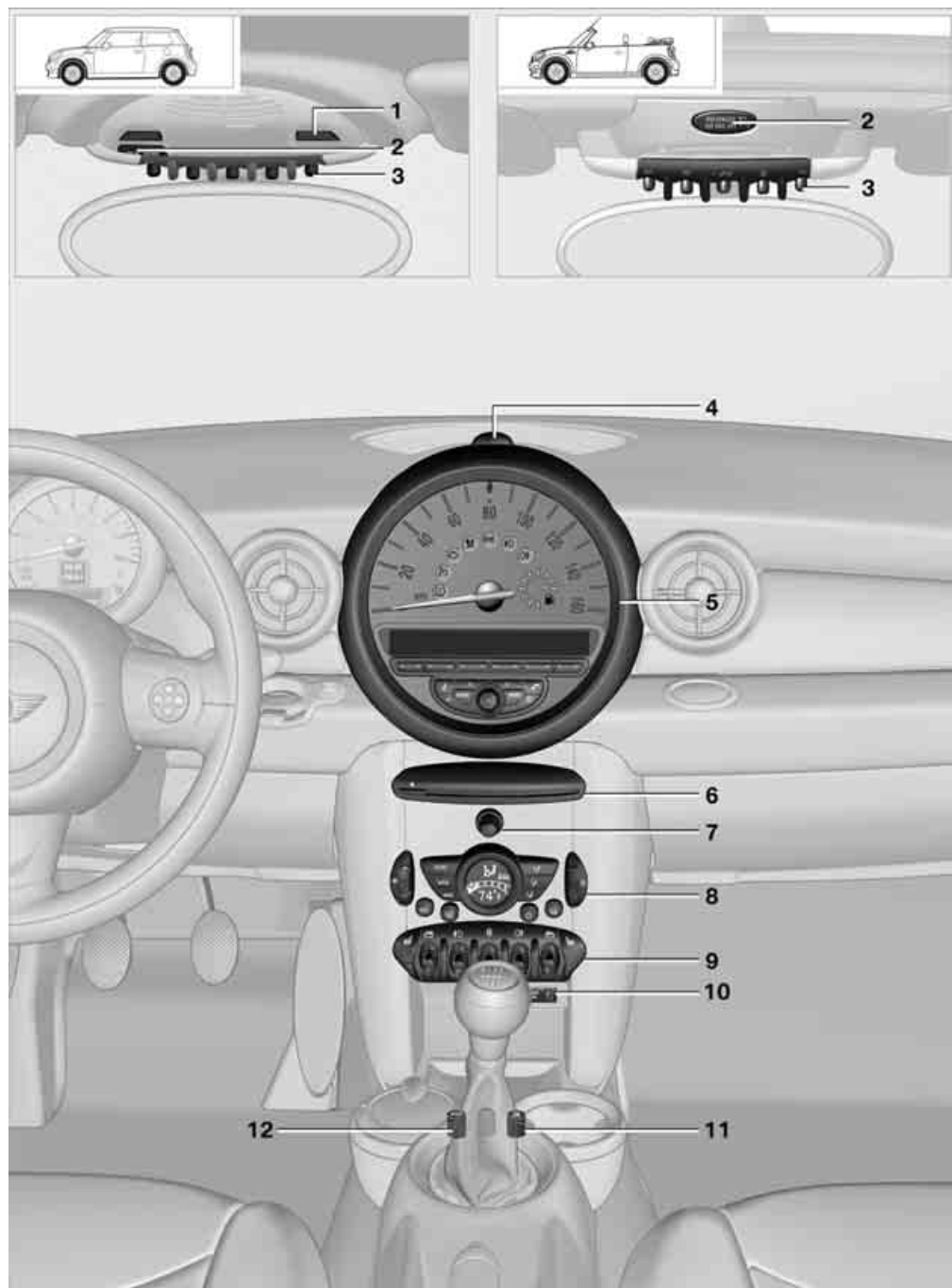



1 MINI: microphone for voice processing system* and for hands-free telephone*
MINI Convertible: microphone in the steering column

2 Indicator/warning lamp* for front passenger airbags 72

3  Reading lamps* 78

 Color of ambient lighting* 78

 Glass sunroof, electric* 28

 MINI Convertible: opening and closing the sliding/tilting roof 30

 Interior lamps 77

4 Hazard warning flashers

5 Speedometer 12

6 Drive for audio CDs

7 Switching audio sources on/off and adjusting volume

8 Air conditioner or automatic climate control*

 Temperature 80, 82

 Recirculated-air mode 80, 82

 Air distribution for air conditioner 81

 Air distribution to the windshield* 82

 Air distribution to the upper body area* 82

 Air distribution to the footwell* 82

AUTO Automatic air distribution and flow rate* 82

MAX Maximum cooling* 82

 Cooling function 80, 83

 Defrosting windows* 81, 83

 Rear window defroster 80, 82

 Windshield heating* 81, 83

 Air flow rate 80, 82

9 Switches in center console

 Seat heating* 38

 Power windows 29

 MINI Convertible: central power window unit 29

 Rear fog lamp* 77

 Fog lamps* 77

 Central locking system, inside 23

10 AUX-IN port, USB audio interface* 86

11 Driving stability control systems

▷ Dynamic Stability Control DSC 64

▷ Dynamic Traction Control DTC* 64

12 Sport button* 65



AT A GLANCE

CONTROLS

DRIVING TIPS

MOBILITY

REFERENCE

OPENING AND CLOSING

KEYS/REMOTE CONTROLS



Remote control

Each remote control contains a rechargeable battery that is recharged when it is in the ignition lock while the car is being driven. You should therefore use each remote control at least twice a year to maintain the charge status. In vehicles equipped with Comfort Access*, the remote control contains a replaceable battery, page 28.

If more than one remote control unit is used, the settings called up and implemented depend on which remote control is recognized when the car is unlocked, refer to Personal Profile, page 18.

In addition, information about service requirements is stored in the remote control, refer to Service data in the remote control, page 119.

New remote controls

Your MINI dealer can supply new remote controls as additional units or as replacements in the event of loss.

Integrated key

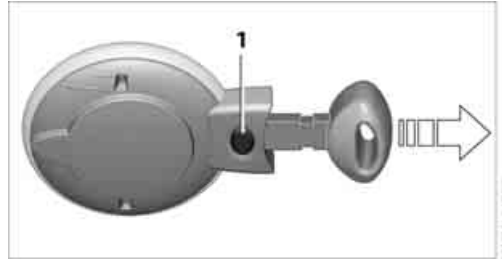

Press button 1 to release the key.

The integrated key fits the following locks:

- ▷ Driver's door, page 22.
- ▷ MINI Convertible: glove compartment, refer to page 85.
- ▷ MINI Convertible: locking the rear seat backrest 95.

PERSONAL PROFILE

The concept

The functions of your MINI can be set individually. By means of Personal Profiles, most of these settings are stored for the remote control currently in use. When you unlock the car, the remote control is recognized and the settings stored for it are called up and implemented.

This means that your settings will be activated for you, even if in the meantime your car was used by someone else with another remote control and the corresponding settings.

At most three remote controls can be set for three different people. A prerequisite is that each person uses a separate remote control.

Personal Profile settings

For more information on specific settings, refer to the specified pages.

- ▷ Response of the central locking system when the car is being unlocked 19
- ▷ Automatic locking of the vehicle 23
- ▷ Triple turn signal activation 48
- ▷ Settings for the displays in the speedometer and tachometer:
 - ▷ 12h/24h mode of the clock, refer to Formats and units of measure 57
 - ▷ Date format, refer to Formats and units of measure 57
 - ▷ Units of measure for fuel consumption, distance covered/remaining distances and temperature, refer to Formats and units of measure 57
- ▷ Light settings:
 - ▷ Pathway lighting 74
 - ▷ Daytime running lights 75
- ▷ Automatic climate control*: activating/deactivating the AUTO program, setting the temperature, air volume and air distribution 81
- ▷ Entertainment:
 - ▷ Audio volume, refer to separate Owner's Manual
 - ▷ Speed-dependent volume, refer to separate Owner's Manual

CENTRAL LOCKING SYSTEM

The concept

The central locking system is ready for operation whenever the driver's door is closed.

The system simultaneously engages and releases the locks on the following:

- ▷ Doors
- ▷ Liftgate
- ▷ Fuel filler flap

Operating from outside

- ▷ Via the remote control
- ▷ Via the door lock*
- ▷ In cars with Comfort Access*, via the door handles on the driver's and passenger's sides.

The anti-theft system is also operated at the same time. It prevents the doors from being unlocked using the lock buttons or door handles. The remote control can also be used to switch on/off the welcome lamps and interior lamps. The alarm system* is also activated or deactivated, page 25.

Operating from inside

Button for central locking system, page 23.

In the event of a sufficiently severe accident, the central locking system unlocks automatically. In addition, the hazard warning flashers and interior lamps come on.

OPENING AND CLOSING: FROM OUTSIDE



Persons or animals in a parked vehicle could lock the doors from the inside. Take the key with you when you leave the vehicle so that the vehicle can be opened from the outside. ◀

Using the remote control

Unlocking

Press the  button.

The welcome lamps and interior lamps come on.

Unlocking mode

You can also set which parts of the car are unlocked. The setting is stored for the remote control in use.

1. Switch on the ignition, refer to page 44.
2. Briefly press the button in the turn indicator lever repeatedly until "SET/INFO" is displayed.



3. Press and hold the button until the display changes.
4. Briefly press the button repeatedly until the symbol and "SET" are displayed.



5. Press and hold the button until the display changes.
6. Briefly press the button repeatedly until the display shows the illustrated symbol, arrow.

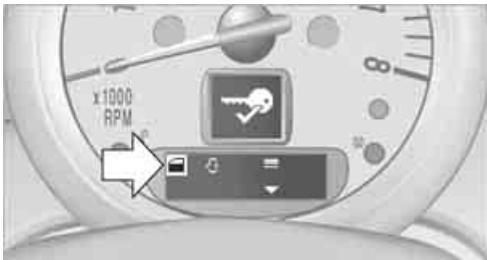

7. Press and hold the button until the display changes.

8. Briefly press the button to select:



Press the  button once to unlock only the driver's door and the fuel filler flap*.

Press the button twice to unlock the entire vehicle.



Press the  button once to unlock the entire vehicle.

9. Press and hold the button until the display changes. The setting is stored for the remote control currently in use.

Convenient opening

Hold the  button down.

The power windows are opened and the glass sunroof* is raised. In the MINI Convertible, the windows and the sliding sunroof are opened.

In order to open the convertible top of your MINI Convertible: release button and push again until the convertible top is completely open. The side window remains open.

With Convenient Access*: when you are close to the vehicle, the windows are raised after the convertible top opens if you continue pressing the  button.



Convenient closing is not possible by means of the remote control. ◀

Locking

Press the  button.



Do not lock the vehicle from the outside if there is any person inside, because the vehicle cannot be unlocked from inside without special knowledge. ◀

MINI Convertible: convenient closing*

When you are close to the vehicle, the remote control for Comfort Access can be used to close the convertible top and the windows.

Hold the  button down.

The convertible top and the windows are closed.

 Watch during the closing process to be sure that no one is injured. Releasing the button interrupts the closing process. ◀

Setting confirmation signals



To have the vehicle confirm when it has been locked or unlocked.

1. Switch on the ignition, refer to page 44.
2. Briefly press the button in the turn indicator lever repeatedly until "SET/INFO" is displayed.





3. Press and hold the button until the display changes.
4. Briefly press the button repeatedly until the symbol and "SET" are displayed.

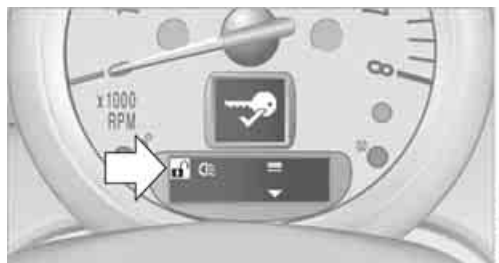

5. Press and hold the button until the display changes.
6. Briefly press the button to select, arrow:
 - ▶  Confirmation signal during unlocking
 - ▶  Confirmation signal during locking



7. Press and hold the button until the display changes.
8. Briefly press the button to select:
 - ▶  The hazard warning flashers light up during unlocking/locking.
 - ▶  An acoustic signal sounds during unlocking/locking.
 - ▶  The hazard warning flashers light up and an acoustic signal* sounds during unlocking/locking.
 - ▶ **off**
The function is deactivated.
9. Press and hold the button until the display changes. The setting is stored.

Switching on interior lamps

While the car is locked:

Press the  button.

You can also use this function to locate your vehicle in parking garages, etc.

Unlocking the liftgate

Press the  button.

 When it is opened, the liftgate swings upward and outward to the rear. Make sure that adequate clearance is available before opening.

To prevent accidentally locking yourself out, do not place the key down in the cargo bay. If the liftgate was locked before opening, it will be locked again after it is closed.

Before and after each trip, check that the liftgate has not been inadvertently unlocked. ◀

Malfunctions

The remote control may malfunction due to local radio waves. If this occurs, unlock and lock the car at the door lock with the integrated key. If the car can no longer be locked with a remote control, the battery in the remote control is discharged. Use this remote control during an extended drive; this will recharge the battery, page 18.

For US owners only

The transmitter and receiver units comply with part 15 of the FCC/Federal Communications Commission regulations. Operation is governed by the following:

FCC ID:
LX8766S
LX8766E
LX8CAS

Compliance statement:

This device complies with part 15 of the FCC Rules. Operation is subject to the following two conditions:

- ▷ This device must not cause harmful interference, and
- ▷ this device must accept any interference received, including interference that may cause undesired operation.

 Any unauthorized modifications or changes to these devices could void the user's authority to operate this equipment. ◀

Using the door lock

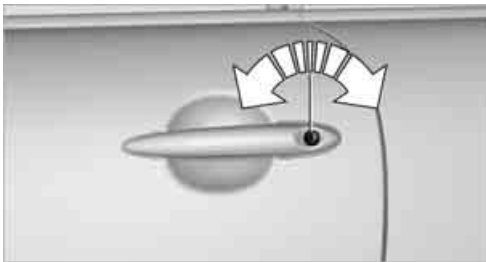

You can set which parts of the car are unlocked, page 19.

 When there is no alarm system* or Comfort Access*, only the driver's door is locked with the door lock. ◀

To lock all doors, the fuel filler flap and the lift-gate together:

With the doors closed, press the interior central locking button, page 23 to lock the vehicle.

Unlocking and opening the driver or passenger door, page 23.

Locking the vehicle.

- ▷ Lock the driver's door with the integrated key via the door lock, or
- ▷ press the safety lock button on the passenger's door and close the door from the outside.

Convenient operation

With an alarm system* or Comfort Access*, the windows and glass sunroof* can be operated via the door lock.

Opening/closing

Hold the key in the position for unlocking or locking.

In the MINI Convertible, the convertible top closes first, followed by the folding sunroof, and finally the side windows close.

 During the roof closing process (in case of the convertible top also during the opening process) ensure no one gets pinched. Releasing the key stops the operation. ◀

Manual operation

In the event of an electrical malfunction, the driver's door can be unlocked or locked by turning the integrated key in the door lock to the end positions.

OPENING AND CLOSING: FROM INSIDE

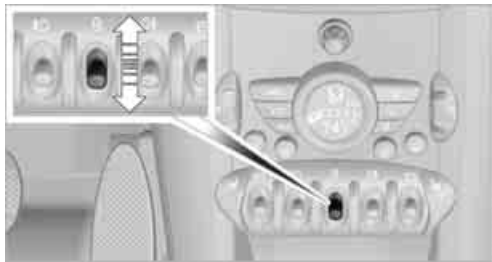

The switch locks or unlocks the doors and lift-gate when the doors are closed, but the anti-theft system is not activated. The fuel filler flap remains unlocked*.

Unlocking and opening

- ▷ Either unlock the doors together using the switch for the central locking system and then pull the door handle above the armrest or
- ▷ pull on the door handle of either door twice: The first time unlocks the door, the second time opens it.

Locking

- ▷ Press the switch or
- ▷ press down the safety lock button of a door. To prevent you from being locked out, the open driver's door cannot be locked using the lock button.

 Persons or animals in a parked vehicle could lock the doors from the inside. Take the key with you when you leave the vehicle so that the vehicle can be opened from the outside. ◀

Automatic locking

You can also set the situations in which the car locks. The setting is stored for the remote control in use.

1. Switch on the ignition, refer to page 44.
2. Briefly press the button in the turn indicator lever repeatedly until "SET/INFO" is displayed.



3. Press and hold the button until the display changes.
4. Briefly press the button repeatedly until the symbol and "SET" are displayed.



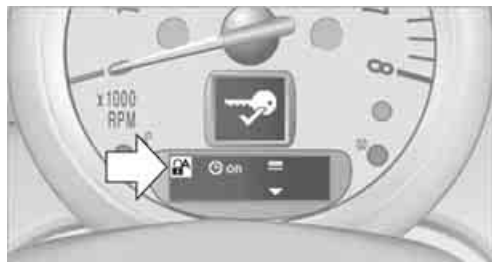

5. Press and hold the button until the display changes.
6. Briefly press the button repeatedly until the display shows the illustrated symbol, arrow.



7. Press and hold the button until the display changes.

8. Briefly press the button to select:

- ▷  **on**
The central locking system automatically locks the vehicle after some time if no door has been opened.
- ▷  **→ on**
The central locking system automatically locks the vehicle as soon as you drive off.
- ▷  **→ off**
The central locking system automatically locks the vehicle after some time if no door has been opened, or as soon as you drive off.
- ▷ **off**
The central locking system remains unlocked.

9. Press and hold the button until the display changes. The setting is stored.

LIFTGATE

 To avoid damage, make sure there is sufficient clearance before opening the liftgate. ◀

Opening

 In some market-specific versions, the liftgate cannot be unlocked using the remote control unless the vehicle is unlocked first. ◀



Press the button in the handle, arrow, or the  button of the remote control, for an extended period. The liftgate is unlocked and can be opened.

MINI Convertible



 The maximum load that may be placed on the open trunk lid is 175 lbs/80 kg. ◀

Manual release in the MINI Convertible

In the event of an electrical malfunction, you can also unlock the liftgate manually.

1. Use the integrated key and open the backrest 1 lock.

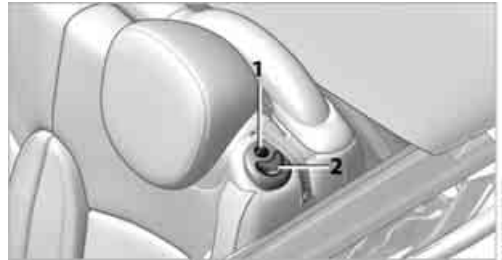

2. Press button 2 and fold down backrest together with the belt strap.



3. Pull the handle, see arrow. The liftgate is released.

Closing

 Make sure that the closing path of the liftgate is clear; otherwise, injuries may occur. ◀



The handle recesses on the interior trim panel of the liftgate make it easier to pull it down.

ALARM SYSTEM*

The concept

The alarm system, when activated, reacts if:

- ▷ A door, the engine compartment lid or the liftgate is opened
- ▷ There is movement inside the car
- ▷ The car's inclination changes, for instance if an attempt is made to jack it up and steal the wheels or to raise it prior to towing away
- ▷ There is an interruption in the power supply from the battery

The alarm system briefly indicates unauthorized entry or tampering by means of:

- ▷ An acoustic alarm
- ▷ Switching on the hazard warning flashers

Arming and disarming

Whenever the car is locked or unlocked, the alarm system is armed or disarmed.

Even when the alarm system is armed, you can open the liftgate by means of the  button on the remote control.

When you subsequently close the liftgate it is again locked and monitored.

-  In certain market-specific versions, unlocking via the door lock triggers the alarm. ◀

Panic mode*

You can activate the alarm system if you find yourself in a dangerous situation.

Press the  button for at least two seconds.

Switching off the alarm:

Press any button.

Switching off an alarm

- ▷ Unlock the car with the remote control.
- ▷ Insert the key fully into the ignition lock.
- ▷ In cars with Comfort Access*, press the button on the door lock.

Display on the revolution counter

When the system is armed, all LEDs pulse. After approx. 16 minutes one LED flashes.



- ▷ LEDs pulse or LED flashes: system is armed.
- ▷ One LED flashes at short intervals: A door, the hood or the liftgate is not properly closed. Even if these are not closed fully, the remaining items are deadlocked and the LEDs pulse after approx. 10 seconds for approx. 16 minutes. Afterwards, one LED flashes. The interior movement detector is not activated.
- ▷ LEDs go out after the vehicle is unlocked: No attempt was made to tamper with the car.
- ▷ LEDs flash after unlocking until the key is inserted in the ignition, but for no longer than approx. 5 minutes: an attempt was made to tamper with the car.

Tilt alarm sensor

The vehicle's inclination is monitored. The alarm is triggered, for instance, if an attempt is made to steal the car's wheels or tow it away.

Interior movement detector

Before the interior movement detector can operate correctly, the windows and glass roof must be closed.

MINI Convertible

The passenger compartment is monitored up to the height of the seat's surface. This way, the anti-theft alarm system including the interior motion sensor are armed, even if the convertible top is open. Falling objects, e.g. tree leaves, may trigger a false alarm, refer to Avoiding false alarms.

Avoiding false alarms

The tilt alarm sensor and the interior movement detector can be switched off together.

This prevents false alarms, e.g. in the following situations:

- ▷ In duplex garages
- ▷ When being transported on car-carrying trains, ferries or trailers
- ▷ If pets are to remain inside the car

Switching off the tilt alarm sensor and interior movement detector

- ▷ Press the  button on the remote control twice in succession.
- ▷ Lock the vehicle twice with the integrated key.

LEDs flash in short succession for approx. 2 seconds.

The tilt alarm sensor and the interior movement detector are switched off until the car is next unlocked and locked.

COMFORT ACCESS*

Comfort Access enables you to enter your vehicle without having to hold the remote control in

your hand. All you need to do is wear the remote control close to your body, e.g. in your jacket pocket. The vehicle automatically detects the remote control within the immediate vicinity or in the passenger compartment.

Functional requirements

- ▷ The vehicle or the liftgate can only be locked when the vehicle detects that the remote control currently in use is outside of the vehicle.
- ▷ The vehicle cannot be locked or unlocked again until after approx. 2 seconds.
- ▷ The engine can only be started when the vehicle detects that the remote control is inside the vehicle.
- ▷ The doors and liftgate must be closed to be able to operate the windows and glass sunroof*.

Comfort Access supports the following functions:

- ▷ Unlocking/locking the vehicle
- ▷ Unlocking the liftgate by itself
- ▷ Starting the engine
- ▷ MINI Convertible: convenience closing and soft-top control with the remote control for Comfort Access

Comparison to standard remote controls

Essentially, it makes no difference whether you control the above-mentioned functions using Comfort Access or by pressing the buttons on the remote control for Comfort Access.

Instructions on opening and closing are found starting on page 18.

Special features regarding the use of Comfort Access are described below.

- ▷ If you notice a brief delay while opening or closing the windows, the glass sunroof or the convertible top, the system is checking whether a remote control is inside the vehicle. Repeat the opening or closing procedure, if necessary. ◀

To unlock

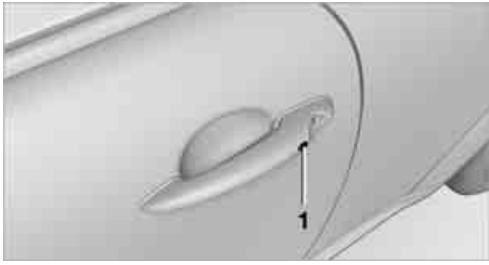

Press button 1.

Depending on the setting, refer to Unlocking mode on page 19, only the driver's door or the entire vehicle is unlocked.

 Press the button again to lock the vehicle again. ◀

Convenient opening with the remote control, refer to page 20.

Locking

Press button 1.

MINI Convertible: if a remote control is inside the vehicle, windows and convertible top can be opened and closed as soon as the remote is operational.

Unlocking the liftgate separately

Press the button on the outside of the liftgate.

 If the vehicle detects that a remote control has been accidentally left inside the locked vehicle's cargo bay after the liftgate is closed, the liftgate will reopen slightly. The hazard warning flashers flash and an acoustic signal* sounds. ◀

Windows and glass sunroof, electric*

If the engine is switched off, you can still operate the windows and glass sunroof so long as a door or the liftgate has not been opened.

If the doors and liftgate are closed again and the remote control is located inside the vehicle, the windows and the glass sunroof can be operated again.

Insert the remote control into the ignition lock to be able to operate the windows or glass sunroof when the engine is switched off and the doors are open.

Switching on radio readiness

Switch on radio readiness by briefly pressing the start/stop button, page 44.

 Do not depress the brake or the clutch; otherwise, the engine will start. ◀

Starting the engine

The engine can be started or the ignition can be switched on when a remote control is inside the vehicle. It is not necessary to insert a remote control into the ignition lock, page 44.

Switching off the engine in cars with automatic transmission

The engine can only be switched off when the selector lever is in position P, page 45.

To switch the engine off when the selector lever is in position N, the remote control must be in the ignition lock.

Before driving a vehicle with automatic transmission into a car wash

1. Insert remote control into ignition lock.
2. Depress the brake.
3. Move the selector lever to position N.
4. Switch off the engine.

The vehicle can roll.

Malfunction

Comfort Access may malfunction due to local radio waves.

If this happens, open or close the vehicle via the buttons on the remote control or using the integrated key.

Insert the remote control into the ignition lock and start the engine.

Warning lamps



The warning lamp comes on when an attempt is made to start the engine: the engine cannot be started. The remote control is not inside the vehicle or is malfunctioning. Take the remote control with you inside the vehicle or have it checked. If necessary, insert another remote control into the ignition lock.



The warning lamp comes on when the engine is running: the remote control is no longer inside the vehicle. After the engine is switched off, the engine can only be restarted within approx. 10 seconds.



The indicator lamp comes on: replace the battery in the remote control.

Replacing the battery

The remote control for Comfort Access contains a battery that will need to be replaced from time to time.

1. Remove the cover.



2. Insert the new battery with the plus side facing up.
3. Press the cover on to close.



Take the old battery to a battery collection point or to your MINI dealer. ◀

GLASS SUNROOF, ELECTRIC*



To prevent injuries, exercise care when closing the glass sunroof and keep it in your field of vision until it is shut.

Take the key with you when you leave the car; otherwise, children could operate the sunroof and possibly injure themselves. ◀

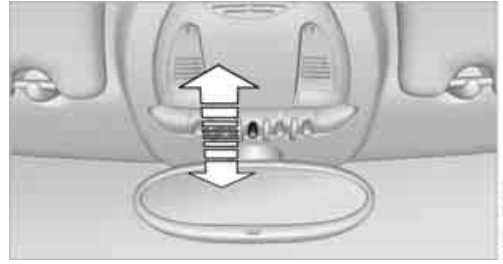

Raising

- ▷ Press the switch backward to the resistance point and hold it there. Both glass sunroofs are raised. Releasing the switch stops the movement.
- ▷ With the ignition switched on, press the switch backward beyond the resistance point. Both closed sunroofs are raised fully. Pressing again stops the movement.

Opening, closing

With the ignition switched on and the glass sunroof raised, press the switch backward and hold it there.

The front glass sunroof opens.

The rear glass sunroof is closed.

Releasing the switch stops the movement.

The glass sunroof can be closed in the same way by pressing the switch forward.

The front glass sunroof remains in a raised position. The rear glass sunroof is raised. Pressing on the switch again closes both sunroofs completely.

Convenient operation via door lock or Comfort Access, refer to page 20, 22, 27.

Roller sun blind

The roller sun blind can be opened and closed independently of the glass sunroof.

Following interruptions in electrical power supply

After a power failure, there is a possibility that the glass sunroof can only be raised. In this case, have the system initialized. The manufacturer of your MINI recommends that you have this work done by your MINI dealer.

WINDOWS

 To prevent injuries, exercise care when closing the windows.

Take the remote control with you when you leave the car; otherwise, children could operate the electric windows and possibly injure themselves. ◀

 If, after a window is opened and closed several times in close succession, the window can only be closed and not opened, the system is overheated. Let the system cool for several minutes with the ignition switched on or the engine running. ◀

Opening

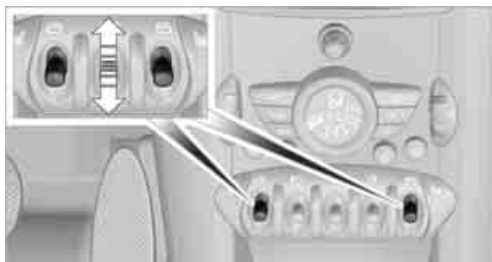

- ▷ Press the switch downwards. The window opens until you release the switch.
- ▷ Tap the switch downwards. As soon as the remote is ready, the windows will open automatically. Tap the switch again to stop the opening movement.

MINI: closing

The window can be closed in the same way by pressing the switch up.

MINI Convertible: closing

In order to close the window, press the switch up. The window closes until you release the switch.

Electric power windows initializing

 If the battery was disconnected, e.g. for changing batteries or vehicle storage, reinitialize the power window switch; otherwise, the windows will not be lowered.

MINI Convertible: opening the convertible top is not possible. ◀

1. Close the doors.
2. Open both windows.
3. Close both windows.

In the event of a system malfunction, please contact your MINI dealer.

MINI Convertible: central power window unit

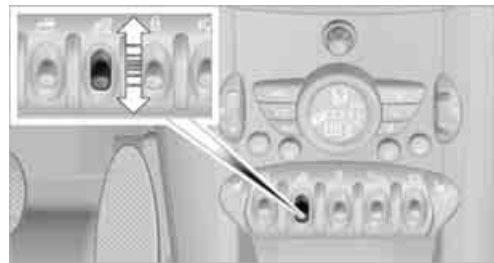

- ▷ Press the switch downwards. First the rear windows, then the front windows open until the button is released.
- ▷ Tap the switch downwards. With ignition turned on: rear and front window open automatically. Tap the switch again to stop the opening movement.

To close the window, push the button upward and hold.

 Do not close the windows until the closing procedure for the convertible top is finished. Otherwise, it is not ensured that the side windows will close properly against the rubber seals of the convertible top. Convertible top, refer to page 31. ◀

After switching off the ignition

When the ignition is switched off, the windows can still be operated for approx. 1 minute as long as no door is opened.

 Take the key with you when you leave the car; otherwise, children could operate the electric windows and possibly injure themselves. ◀

MINI: pinch protection system

This function does not apply to the MINI Convertible.

If the closing force exceeds a specific value as a window closes, the closing action is interrupted and the window reopens slightly.

 Even though there is the pinch protection system, always ensure that the window's travel path is clear; otherwise, the safety system might fail to detect certain kinds of obstructions, such as thin objects, and the window would continue closing.

Do not install any accessories that might interfere with window movement. Otherwise, the pinch protection system could be impaired. ◀

Closing without pinch protection

If there is an external danger, or if ice on the windows, etc., prevents you from closing the windows normally, the window can be closed manually.

1. Press the switch upward and hold it there. Pinch protection is limited and the window reopens slightly if the closing force exceeds a certain value.
2. Press the switch upward again within approx. 4 seconds and hold it there. The window closes without pinch protection.

CONVERTIBLE TOP WITH INTEGRATED SLIDING SUNROOF

 To conserve battery power, if possible operate the convertible top only while the engine is running.

Prior to closing the convertible top, check for and remove all debris from the windshield frame; otherwise, the closing of the top may be hampered. ◀

Opening and closing the sliding sunroof

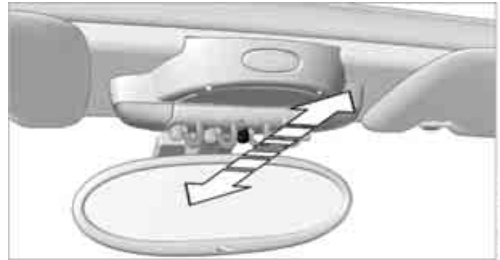

To open:

Press the switch backward until the desired position or the end position is reached.

To close:

Press the switch forward.

The sliding sunroof can be operated up to a road speed of 74 mp/120 km/h.

Power convertible top

The fully automatic convertible top provides protection from the weather, combined with simple and easy operation.

So that you can get the most enjoyment out of your MINI Convertible, here are some helpful tips:

- ▷ It is recommended that you close the convertible top whenever the vehicle is parked. The closed convertible top not only protects the vehicle interior from damage due to unforeseen bad weather, but also provides a certain degree of protection against theft. Always keep your valuables inside the locked luggage compartment, even if the convertible top is closed.
- ▷ Do not mount any roof rack systems on the convertible top.
- ▷ When opening the wet convertible top, e.g., after driving in the rain, water drops may enter the luggage compartment. In order to avoid water stains or soiling, remove all objects from the luggage compartment, if necessary.

 If the temperature drops below +10 °F / -12 °C, do not operate the convertible top; otherwise, damage may occur.

Do not leave a wet convertible top open for more than one day, since the humidity may cause damages.

Do not place any objects on the convertible top, as they could otherwise fall off while the convertible top is being operated and result in property damage or personal injury.

If the rollover protective system is extended, do not operate the convertible top.

Always completely finish the operation of the convertible top. Driving off before an opening or closing procedure is completely finished can lead to property damage or personal injury.

Do not reach into the moving parts during the opening and closing procedure. Keep children away from the pivoting range of the convertible top.

For safety reasons, only operate the convertible top while the vehicle is standing. ◀

 While opening and closing, the convertible top pivots upward. If operating the convertible top inside a garage or under a bridge, or similar low structure, ensure the minimum clearance is 7 ft/2 m; otherwise, the vehicle may be damaged. ◀

Before opening and closing

- ▷ Please observe the previous safety instructions.
- ▷ Please ensure the luggage compartment roller cover is in its lowest position, refer to page 95; otherwise, the convertible top cannot be opened.
- ▷ Ensure the cargo does not push against the luggage compartment roller cover from below.
- ▷ Ensure that the liftgate is closed.

Opening and closing the convertible top



To open:

Press the switch backward in order to open the sliding/tilting sunroof. Pressing the button again opens the convertible top.

To close:

Press the switch forward

Operating while driving

The convertible top may be opened or closed while driving not faster than 20 mph/30 km/h.

 While operating the convertible top, pay close attention to the surrounding traffic; otherwise, an accident may happen. Try to avoid operating the convertible top while reversing the vehicle since the rear view is very limited during the convertible top's movement. Do not operate the convertible top when driving on winding and rough roads or during windy conditions. ◀

For better control

- ▷ The LED lights up during convertible top operation until the opening or closing procedure is completely finished.
- ▷ The LED flashes after releasing the switch. The opening or closing procedure has not yet been completed. The procedure can be continued in the desired direction by pressing the appropriate button.
- ▷ The indicator lamp Convertible top not locked, refer to page 141, lights up.

Interruption

 A convertible top which is not completely open or closed is hazardous. ◀

The automatic movement is immediately interrupted when the button for the convertible top operation is released. The procedure can be continued in the desired direction by pressing the appropriate button.

If the opening or closing procedure is interrupted by releasing the respective button, the convertible top stays in its current position for several seconds before it slowly moves into a more stable position. The procedure can be continued by pressing the appropriate button.

The opening and closing procedure is also interrupted in case of a mechanical blockage. In this case, in order to operate the convertible top again:

1. Turn off the ignition and then switch it on again.
2. Press the button to continue the procedure in the desired direction.

Opening and closing procedure

 Do not interrupt and restart the closing procedure several times one after another, or the convertible top mechanism could be damaged. ◀

 If the convertible top can be moved in only one direction after several consecutive attempts to operate it, the convertible top system has overheated. Allow the system to cool down for approx. 4 minutes. ◀

 If the battery was disconnected, e.g. for changing batteries or vehicle storage, reinitialize the power windows, refer to page 29. Otherwise, the windows cannot be lowered or the convertible top cannot be opened. ◀

Convenient operation

For convenient operation using the remote control, refer to page 19; for operation via the door lock, refer to page 22.

Manual closing in the event of an electrical malfunction

 Only close the convertible top manually if it is absolutely necessary. Never open it manually. Improper handling of the convertible top can result in damage. The closing procedure must be completely finished. Otherwise, damage or injury could result. ◀

Before closing

1. Remove allen key and screwdriver from vehicle tools, refer to page 125.
2. Pry out luggage compartment lamp from the left side trim using the screwdriver.



3. Use the screwdriver and turn the gold-colored screw, see arrow, one and a half turns in the direction of the arrow.

Releasing the convertible top

1. Push cover panel forward, see arrow 1.
2. In order to unlock the convertible top use the allen key to loosen the screws of the locking devices, see arrows 2.



3. Release the second side frame.

Closing the convertible top

1. Place both hands on the convertible top on the respective side frame.

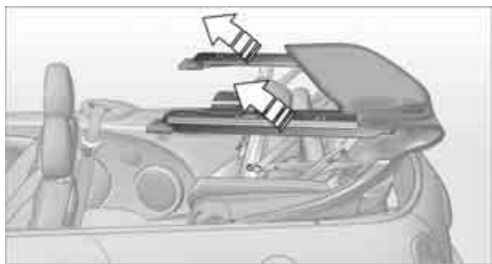

2. Lift out both sides at the same time, and swing the convertible top forward onto the cowl.
3. Inside the vehicle, use a screwdriver to pry out the cover in the center of the roof.

To close the sliding sunroof

1. Insert the hexagon wrench into the recess in the center of the roof and push upward, see arrow 1.

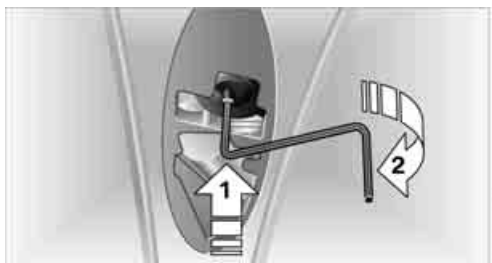

2. Turn the hexagon wrench in the direction of arrow 2.
3. Open both locking mechanisms and remove the locking pieces.

4. Insert the pins into the respective recess in the cowl, see arrow.

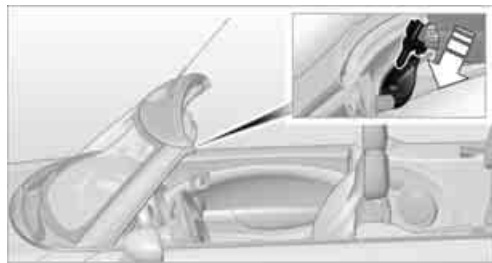

To lock the convertible top

Turn hexagon wrench in the opposite direction of arrow 2 until the convertible top is securely locked.

-  Please contact your MINI dealer to have the electrical malfunction repaired. ◀

WIND DEFLECTOR*

With the convertible top open, the wind deflector keeps air movement in the passenger compartment to a minimum, thus providing you with a more pleasant drive, even at higher speeds.

-  Do not let the wind deflector come into contact with pointy objects as these may damage the net. Do not place objects on the installed wind deflector. When stowing the wind deflector, ensure that it is not damaged by objects. ◀

Before installing

1. Take the wind deflector out of the pouch.
2. Unfold the wind deflector, see arrows 1.

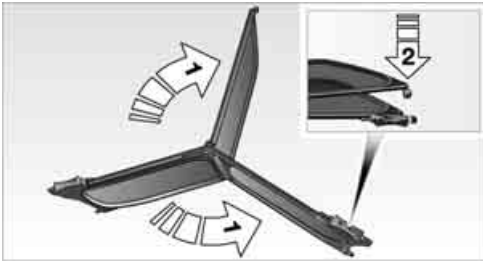

3. Press the locking device together until it engages, see arrow 2.

Installing and folding up



1. Push out retaining pin 2 on one side until it engages.
2. Insert wind deflector with retaining pins into the openings 1 and 2 on that side of the vehicle.
3. On the opposite side of the vehicle, insert the retaining pin 1 into the opening, pushing against the spring load.
4. Push out retaining pin 2 on one side until it engages.



5. Fold up the upper part of the wind deflector.

⚠ If a seat is in its rearmost position, do not recline the backrest too far; otherwise, the wind deflector could be damaged. ◀

Removing and folding

Remove the deflector following the reverse sequence.

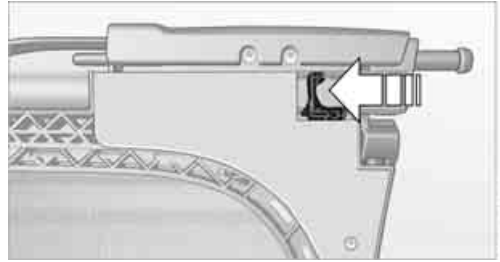

Push the release lever towards the center of the wind deflector and fold both halves together.

ADJUSTMENTS

SITTING SAFELY

The ideal sitting position can make a vital contribution to relaxed, fatigue-free driving. In conjunction with the safety belts, the head restraints and the airbags, the seated position has a major influence on your safety in the event of an accident. To ensure that the safety systems operate with optimal efficiency, we strongly urge you to observe the instructions contained in the following section.

For additional information on transporting children safely, refer to page 41.

Airbags

 Always maintain an adequate distance between yourself and the airbags. Always grip the steering wheel on the rim, with your hands in the 3 o'clock and 9 o'clock positions, to minimize the risk of injury to the hands or arms in the event of the airbag being triggered off. No one and nothing should come between the airbags and the seat occupant. Do not use the cover of the front airbag on the front passenger side as a storage area. Ensure that the front passenger is correctly seated, e.g. that no feet or legs are propped against the dashboard. Otherwise, leg injury could result if the front airbag suddenly deployed. Make sure that occupants keep their heads away from the side airbag and do not lean against the head-level airbag in the MINI; otherwise injuries can occur when the airbag is triggered. ◀

Even if you follow all the instructions, injuries resulting from contact with airbags cannot be fully excluded, depending on the circumstances. The ignition and inflation noise may provoke a mild hearing loss in extremely sensitive individuals. This effect is usually only temporary.

For airbag locations and additional information on airbags, refer to page 71.

Head restraint

A correctly adjusted head restraint reduces the risk of neck injury in the event of an accident.

 Adjust the head restraint in such a way that its center is at approx. ear level. Otherwise, there is an increased risk of injury in the event of an accident. ◀

Head restraints, refer to page 37.

Safety belt

Before every drive, make sure that all occupants wear their safety belts. Airbags complement the safety belt as an additional safety device, but they do not represent a substitute.

Number of safety belts

 Never allow more than one person to wear a single safety belt. Never allow infants or small children to ride in a passenger's lap.

Make sure that the belt in the lap area sits low across the hips and does not press against the abdomen. The safety belt must not rest against the throat, run across sharp edges, pass over hard or fragile objects or be pinched. Fasten the safety belt so that it is pulled taut across the lap and shoulder, fitting the body snugly without any twists. Otherwise, the belt could slide over the hips in the event of a frontal collision and injure the abdomen. Avoid wearing bulky clothing and regularly pull the belt in the upper-body area taut; otherwise, its restraining effect could be impaired. ◀

Safety belts, refer to page 38.

SEATS

Note before adjusting

 Never attempt to adjust your seat while the vehicle is moving. The seat could respond with unexpected movement, and the ensuing loss of vehicle control could lead to an accident.

On the front passenger seat as well, do not incline the backrest too far to the rear while the vehicle is being driven; otherwise, there is a danger in the event of an accident of sliding under the safety belt, eliminating the protection normally provided by the belt. ◀

Comply with the instructions on head restraint height on page 37 and on damaged safety belts on page 39.

Seat adjustment

 Observe the instructions on page 35 to ensure the best possible personal protection. ◀



Longitudinal adjustment

Pull the lever, arrow 1, and slide the seat into the desired position, arrows 2.

After releasing the lever, move the seat slightly forward or back so that it engages properly.

Height

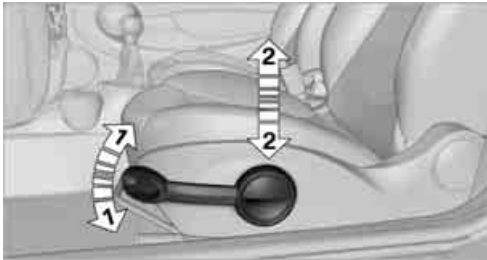

Pull up or push down the lever repeatedly, arrows 1, until the desired height is reached, arrows 2.

Backrest

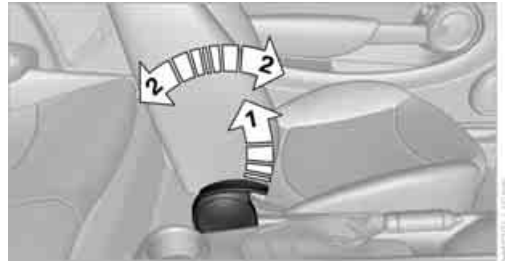

Pull the lever, arrow 1, and apply your weight to the backrest or lift it off, as necessary, arrows 2.

Lumbar support*

You can also adjust the contour of the backrest to obtain additional support in the lumbar region.

The upper hips and spinal column receive supplementary support to help you maintain a relaxed, upright sitting position.

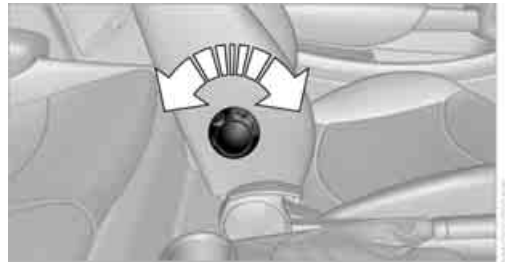

Turn the wheel to increase or decrease the curvature.

Entry to the rear

Easy entry on the driver's side

The easy entry feature includes a mechanical memory function for the longitudinal adjustment and backrest angle.

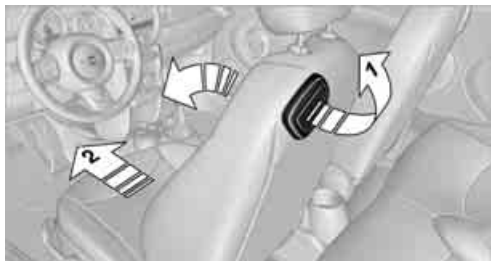

1. Pull up the lever on the seat backrest, arrow 1.
The backrest folds forward.
2. Move the seat forward by pushing on the backrest, arrow 2.

Previous position

1. Push the seat back into its previous position.

 Do not fold the backrest up until the seat is in its previous position. Otherwise, the seat will engage in its current position. In this case, adjust the longitudinal position manually, page 36. ◀

2. Fold the backrest back up to lock the seat.

 When moving the seat backwards, ensure that you do not cause personal injury or property damage.

Before driving off, engage the front seats and seat backrests. Otherwise, there is a risk of accident due to unexpected movement. ◀

HEAD RESTRAINTS

Correctly adjusted head restraint

A correctly adjusted head restraint reduces the risk of neck injury in the event of an accident.

 Correctly adjust the head restraints of all occupied seats; otherwise, there is an increased risk of injury in an accident. ◀

Height

Adjust the head restraint so that its center is approximately at ear level.

Distance

Adjust the distance so that the head restraint is as close as possible to the back of the head.

Height adjustment

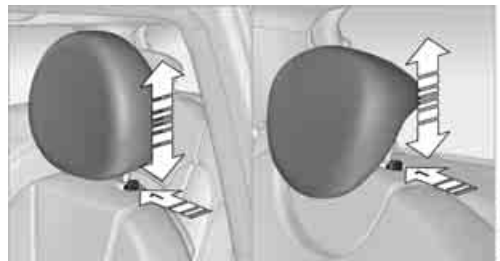

To raise: pull up.

To lower: press the button, arrow 1, and slide the head restraint down.

Removing

Only remove a head restraint if no one will be sitting on the seat in question.

 Reinstall the head restraint before transporting passengers, as otherwise the head restraint cannot provide its protective function. ◀

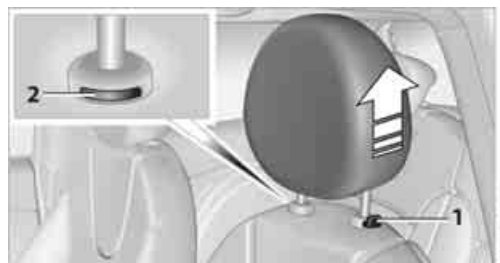

MINI: front

1. Pull up as far as it will go.
2. Fold the backrest forward slightly.
3. Press button 1 and pull the head restraint out as far as it will go.
4. Fold back the backrest.

MINI Convertible: front

1. Pull up as far as it will go.
2. Fold the backrest forward slightly.
3. Press button **1** and pull the head restraint out as far as it will go.
4. Additionally press button **2** and pull the head restraint out completely.
5. Fold back the backrest.

Rear

1. Pull up as far as it will go.
2. Press button **1** and pull the head restraint out completely.

SEAT HEATING***Switching on**

Press once for each temperature level. Three LEDs indicate the highest temperature. If you continue driving within the next 15 minutes, the seat heating is automatically activated at the previously set temperature.

The temperature is lowered or the heating is switched off entirely to save on battery power. The LEDs stay lit.

Switching off

Press button longer.

SAFETY BELTS

Observe the instructions on page 35 to ensure the best possible personal protection. ◀

Before every drive, make sure that all occupants wear their safety belts. Airbags complement the safety belt as an additional safety device, but they do not represent a substitute.

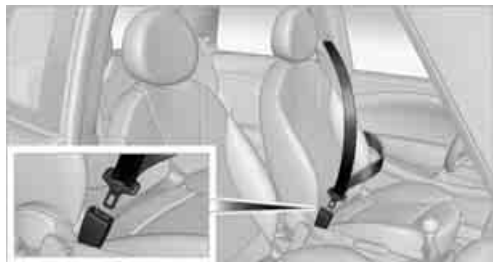
Front and rear seats**Closing**

Make sure you hear the lock engage in the belt buckle.

The upper belt anchor is suitable for adults of any stature as long as the seat is adjusted properly, page 35.

Opening

1. Grasp the belt firmly.
2. Press the red button in the buckle.
3. Guide the belt into its reel.

MINI Convertible: rear belt guide

Please ensure that the belt guide loop, arrow, is locked when putting on the rear seat belts. ◀



Safety belt reminder

Front seats



The indicator lamps come on and an acoustic signal sounds. Check whether the safety belt has been fastened correctly. The "Fasten safety belts"



reminder is issued when the driver's safety belt has not been fastened. The "Fasten safety belts" reminder is also activated at road speeds above approx. 5 mph or 8 km/h if the front passenger's safety belt has not been fastened, if objects are placed on the front passenger seat, or if driver or front passenger unfasten their safety belts.

Damage to safety belts



If the safety belts are damaged or stressed in an accident: have the safety belt system and its seat-belt tensioners replaced and the belt anchors checked. Have this work carried out only by a MINI dealer or by a workshop that has specially trained personnel working in accordance with the specifications of the MINI manufacturer; otherwise, correct operation of these safety systems is not ensured. ◀

MIRRORS

Exterior mirrors



The front passenger's mirror is more convex than the driver's mirror. The objects seen in the mirror are closer than they appear. Do not gauge your distance from traffic behind you on the basis of what you see in the mirror; otherwise, there is an increased risk of an accident. ◀

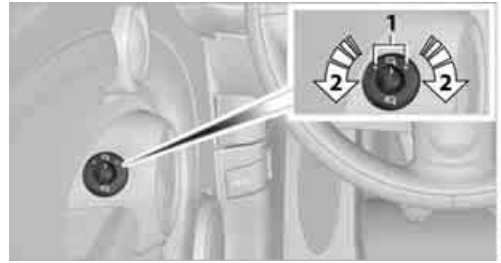

- 1 Adjusting the left or right exterior mirror
- 2 Folding mirrors in and out*

Manual adjustment

The mirrors can also be adjusted manually: press the edge of the glass.

Folding mirrors in and out*

Turn the knob beyond the pressure point in direction 2. The mirrors can be folded in at road speeds up to approx. 20 mph/30 km/h.

This can be beneficial in narrow streets, for example, or for moving mirrors that were folded in by hand back out into their correct positions.

Automatic heating*

At outside temperatures below a certain limit, both exterior mirrors are automatically heated while the engine is running or the ignition switched on.

Interior rearview mirror

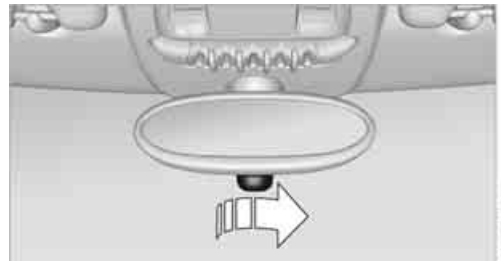

To reduce glare from vehicles behind you when you are driving at night:

Turn the knob.

Interior mirror, automatic dimming*

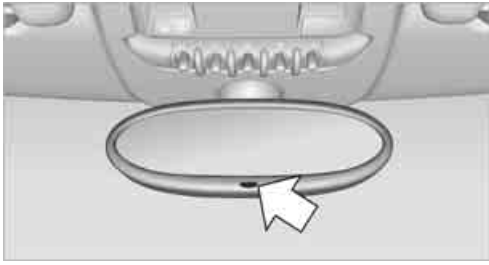

The automatic dimming feature of the interior rearview mirror* is controlled by two photo cells in the mirror. One photo cell is in the mirror frame, arrow; the other is on the back of the mirror.

In order to ensure that the system functions correctly, keep the photo cells clean, do not cover the area between the interior rearview mirror and windshield, and do not affix adhesive labels or stickers of any kind to the windshield directly in front of the mirror.

 Do not use force to swing the lever back up; otherwise, the mechanism will be damaged. ◀

STEERING WHEEL

Adjustments

 Do not adjust the steering wheel position while the car is in motion; otherwise, there is a risk of accident due to an unexpected movement. ◀

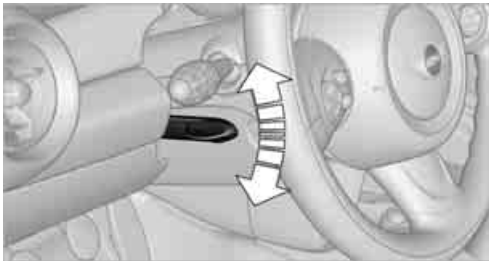

1. Fold the lever down.
2. Move the steering wheel to the preferred distance and angle to suit your seated position.
3. Swing the lever back up.

TRANSPORTING CHILDREN SAFELY

THE RIGHT PLACE FOR CHILDREN

 Do not leave children unattended in the vehicle; otherwise, they could endanger themselves and/or other persons by opening the doors, for example. ◀

Children should always sit in the rear

Accident research has shown that the safest place for children is on the rear seat.

 Only transport children under the age of 13 or smaller than 5 ft/150 cm in the rear in a child restraint system suitable for their age, weight and size. Otherwise, there is an increased risk of injury in the event of an accident. ◀

Children 13 years of age or older must be buckled in with a safety belt as soon as there no longer is any child restraint system that is appropriate for their age, size and weight.

 Only install child seats in the rear when the rear seat backrest is folded all the way back and engaged. Otherwise, there is an increased risk of injury in the event of an accident. ◀

Exception for front passenger seat

Front passenger airbags

 Should it be necessary to use a child restraint system on the front passenger seat, the front and side airbags must be deactivated. Otherwise, there is an increased risk of injury to the child if the airbags deploy, even if the child is seated in a child restraint system. ◀

For more information on automatic deactivation of the front passenger airbags, refer to page 72.

CHILD RESTRAINT SYSTEMS, INSTALLATION

 Observe the child restraint system manufacturer's instructions when selecting, installing and using child restraint systems. Otherwise, the protective effect may be diminished. ◀

On the front passenger seat

 After installing a child restraint system on the front passenger seat, make sure that the front and side airbags for the front passenger are deactivated; otherwise, there is an increased risk of injury if the airbags deploy. ◀

Seat position

Before installing a child restraint system, move the front passenger seat as far back and up* as possible to obtain the best possible position for the belt. Do not change the seat position after this.

Child seat security



All rear safety belts and the safety belt for the front passenger can be prevented from being pulled out in order to secure child restraint systems.

To lock the safety belt

1. Secure the child restraint system with the belt.
2. Pull the belt strap all the way out.
3. Allow the belt strap to retract and pull it taut against the child restraint system.

The safety belt is locked.

To unlock the safety belt

1. Open the belt buckle.
2. Remove the child restraint system.
3. Allow the safety belt strap to retract all the way.

LATCH CHILD-RESTRAINT FIXING SYSTEM

LATCH: lower Anchors and Tethers for Children.

! To install and use the LATCH child restraint system, follow the operating and safety instructions provided by the manufacturer of the system; otherwise, the protective function of the seat may be compromised. ◀

Anchor points for LATCH anchors

Before installing the child seat, pull the belt out of the area for the child-restraint fixing system.



The anchor points for the lower LATCH anchors are located behind the labeled protective caps.

! Make sure that both lower LATCH anchors are properly engaged and that the child restraint system rests firmly against the seat backrest; otherwise, the protective function of the seat may be compromised. ◀

Child restraint system with tether strap

! Use the tether strap anchors to secure child restraint systems only; otherwise, the anchors could be damaged. ◀

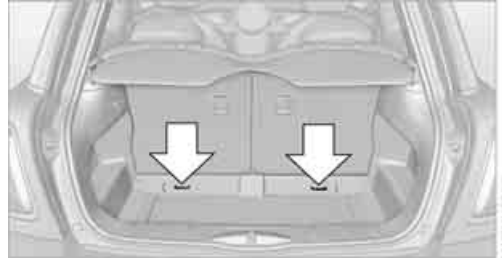

There are two additional anchors for child restraint systems with tether straps, arrows.

Placement of the tether strap

! Make sure the upper retaining strap does not run over sharp edges and is not twisted as it passes to the top anchor. Otherwise, the strap will not properly secure the child restraint system in the event of an accident. ◀

MINI

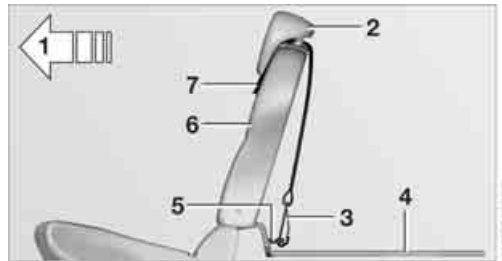

- 1 Direction of travel
 - 2 Head restraint
 - 3 Tether strap hook
 - 4 Cargo bay floor
 - 5 Anchor
 - 6 Seat backrest
 - 7 Tether strap of the child restraint system
1. Push the head restraint upward.
 2. Guide the tether strap between the head restraint holders.

3. Attach the tether strap to the anchor using the hook.
4. Push the head restraint into its lowermost position.
5. Attach the tether strap to the anchor using the hook.
6. Pull the retaining strap tight.

MINI Convertible

▶ Ensure that the upper strap **9** is passed between the seat backrest **8** and the roll-over protection system with cross member **3**; otherwise, the strap will not properly secure the child restraint system. ◀

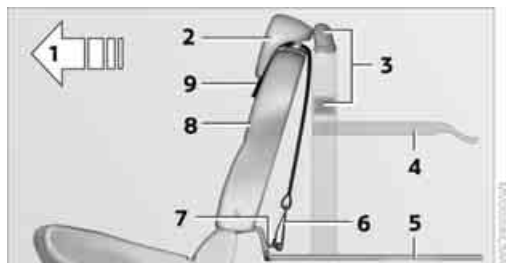

- 1 Direction of travel
- 2 Head restraint
- 3 Rollover protection system with cross member
- 4 Cargo bay cover
- 5 Cargo bay floor
- 6 Tether strap hook
- 7 Anchor
- 8 Seat backrest
- 9 Tether strap of the child restraint system

1. Push the head restraint upward.
2. Unlock backrest and slightly fold forward, refer to page 95.
3. Guide the tether strap between the head restraint holders.
4. Attach the tether strap to the anchor using the hook.
5. Fold backrest back and lock in place. Push headrest down as far as possible.
6. Pull the retaining strap tight.

DRIVING

IGNITION LOCK

Inserting the key into the ignition lock

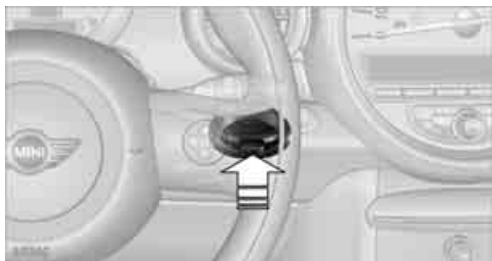

Insert the key all the way into the ignition lock.

Radio readiness

Individual electrical consumers can operate.

Removing the key from the ignition lock

Press in the key briefly. It is ejected slightly.

At the same time:

- ▷ The ignition is switched off if it was on beforehand.

Automatic transmission

You cannot take out the key unless the selector lever is in the P position: interlock.

START/STOP BUTTON



Press the start/stop button to switch radio readiness or the ignition on and off. Do not depress the brake or clutch while doing so.

- ▷ When you press the start/stop button and depress the clutch if the car has manual transmission or the brake if the car has automatic transmission, the engine starts. ◀

Radio readiness

Individual electrical consumers can operate. The time and outside temperature are displayed in the tachometer.

Radio readiness is switched off automatically:

- ▷ When the key is removed from the ignition lock
- ▷ When using Comfort Access* by pushing the button on the door handle or the  button on the remote control, refer to Locking on page 27
- ▷ after a certain has elapsed

Ignition on

Most indicator and warning lamps in indicator area 1, page 13, light up for varying lengths of time.

- ▷ When the engine is off, switch off the ignition and any unnecessary electrical consumers in order to preserve the battery. ◀

Radio readiness and ignition off

All indicator and warning lamps in the displays go out.

The ignition automatically turns off* when the driver's door is opened. Pressing the start/stop button again switches the ignition back on.

The ignition is not switched off in situations such as the following:

- ▷ The clutch or brake is depressed
- ▷ The low beams are switched on

STARTING THE ENGINE

 Do not allow the engine to run in enclosed areas; otherwise, inhalation of the noxious exhaust gases can lead to loss of consciousness and death. Exhaust gases contain carbon monoxide, an odorless and colorless, but highly toxic gas. Never leave an unattended vehicle with the engine running; otherwise, such a vehicle represents a potential safety hazard.

Before leaving the car while the engine is running, place the transmission in neutral or move the selector lever to position P and forcefully apply the parking brake to prevent the car from moving. ◀

 Avoid frequent starting in quick succession or repeated start attempts in which the engine does not start. Otherwise, the fuel is not burned or inadequately burned and there is a danger of overheating and damaging the catalytic converter. ◀

Do not let the engine warm up with the vehicle at a standstill. Move off immediately at a moderate engine speed.

When starting the engine, do not depress the accelerator pedal.



Manual transmission

Key in ignition lock or inside vehicle with Comfort Access, refer to page 26.

1. Depress the brake.
2. Depress the clutch.
3. Press the start/stop button.

Automatic transmission

Key in ignition lock or inside vehicle with Comfort Access, refer to page 26.

1. Depress the brake.
2. Shift the selector lever into position P or N.
3. Press the start/stop button.

The starter operates automatically for a certain time, and stops automatically as soon as the engine has started.

SWITCHING OFF THE ENGINE

 Always take the key with you when you leave the vehicle.

When parking, apply the parking brake forcefully; otherwise, the vehicle could begin to roll. ◀

Manual transmission

1. With the car at a standstill, press the start/stop button.
2. Shift into first gear or reverse.
3. Forcefully apply the parking brake.

Automatic transmission

1. With the car at a standstill, move the selector lever to position P.
2. Press the start/stop button.
3. Forcefully apply the parking brake.

Before driving into a car wash

By following these steps, the vehicle is able to roll:

1. Place the remote control, even with Comfort Access, in the ignition lock.
2. Depress the brake.
3. Move the selector lever to position N.
4. Switch off the engine.

PARKING BRAKE

The parking brake is primarily intended to prevent the vehicle from rolling while parked; it brakes the rear wheels.

Applying

The lever locks in position automatically.

Releasing

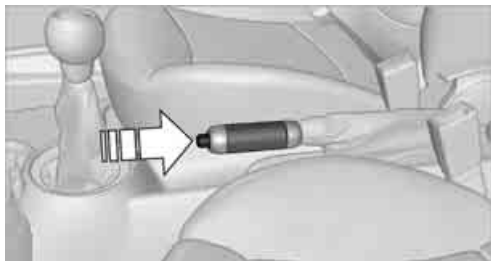

Pull slightly upwards, press the button and lower the lever.

⚠ In exceptional cases, if the parking brake has to be used to slow or stop the car, do not pull the lever up too hard. In doing so, continuously press the button of the parking brake lever.

Otherwise, excessive force could lead to over-braking and loss of traction, i.e. fishtailing, at the rear axle. ◀

MANUAL TRANSMISSION

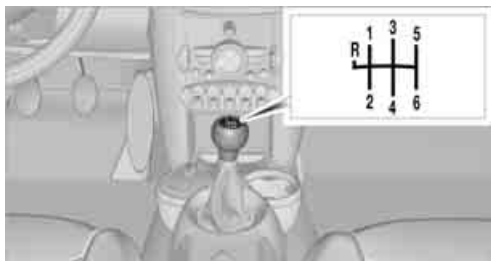

⚠ When shifting into 5th or 6th gear, press the gearshift lever to the right. Otherwise, the engine could be damaged if you inadvertently shift into 3rd or 4th gear. ◀

Reverse gear

Select this only when the vehicle is stationary. When the gearshift lever is pressed to the left, a slight resistance has to be overcome.

AUTOMATIC TRANSMISSION* WITH STEPTRONIC

In addition to the fully automatic mode, you can shift gears manually using Steptronic, page 47.

Parking the vehicle

⚠ To prevent the vehicle from rolling, always select position P and apply the parking brake before leaving the vehicle with the engine running. ◀

Removing the key

1. Move the selector lever to position P.
2. Switch off the engine.
3. Remove the key.

Selector lever positions

P R N D M/S + -

Displays in the tachometer



P R N D S M1 to M6

The selector lever position is displayed, or the current gear in the manual mode.

Changing selector lever positions

- ▷ The selector lever can only be moved out of position P if the ignition is switched on or the engine is running: interlock.
- ▷ Before moving the lever away from P or N with the vehicle stationary, first depress the brake; otherwise, the selector lever will refuse to move: shiftlock.

⚠ To prevent the vehicle from creeping after you select a driving position, depress the brake until you are ready to start. ◀

A lock prevents accidental shifting into selector lever positions R and P.

Overriding the selector lever lock



Press the button on the front of the selector lever, arrow.

P Park

Select this only when the vehicle is stationary. The transmission locks to prevent the drive wheels from turning.

R Reverse

Select this only when the vehicle is stationary.

N Neutral

Select this when you are in a car wash, for example. The vehicle can roll.

D Drive, automatic position

Position for normal vehicle operation. All forward gears are selected automatically.

Under normal operation conditions, fuel consumption is lowest when you drive in position D.

Kickdown

Kickdown enables you to achieve maximum performance.

Depress the accelerator pedal beyond the full-throttle resistance point.

Sport program and manual operation M/S



Move the selector lever from position D to the left into the M/S shifting slot: The Sport program is activated and DS is displayed. This position is recommended for a performance-oriented driving style.

To deactivate the sport program or manual mode M/S, move the selector lever to the right into position D.

Shifting with the selector lever

Push the selector lever forward or pull it back to activate manual operation. Steptronic shifts the gear.

- ▷ Pull the selector lever in the + direction. Transmission shifts up.
- ▷ Push the selector lever in the – direction. Transmission shifts down.

The selected gear is displayed in the tachometer, e.g. M1.

To use the automatic mode again, move the selector lever to the right into position D.

Upshifts and downshifts are executed only when they will result in a plausible combination of engine and vehicle speed; thus, for example, a downshift that would cause the engine to over-rev will not be executed by the system. The selected gear is displayed briefly, followed by the current gear.

Shifting on the steering wheel*

With the selector lever in position D, automatic drive, you can shift gears using the shift paddles on the steering wheel. The transmission automatically switches to manual mode.

If you do not shift gears with the shift paddles or accelerate for a certain amount of time, the transmission automatically returns to D, automatic drive.



- ▷ Pull one of the shift paddles. Transmission shifts up.
- ▷ Push one of the shift paddles. Transmission shifts down.

M1 to M6 is displayed in the gear indicator.

Manually unlock the selector lever lock

Should the selector lever refuse to move out of position P even though the ignition is switched on, the brake is depressed and the button on the selector lever is pressed, the selector lever lock can be overridden:

1. Unclip the sleeve of the selector lever.
2. Pull the sleeve up over the selector lever until the sleeve is inside out. Disconnect the cable connector if necessary.

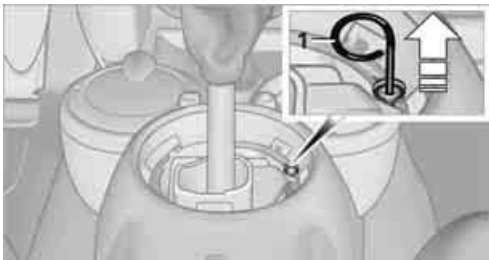

3. Insert extractor hook 1 from the onboard vehicle tool kit into the loop on the passenger's side.
4. Pull the loop up.
5. Move the selector lever into the desired position by pressing the button on the front of the selector lever.

▷ Only unlock the selector lever lock manually when the vehicle is to be towed. Do not forget to firmly apply the parking brake prior to the tow; otherwise, the vehicle may roll away. ◀

TURN SIGNALS/ HEADLAMP FLASHER

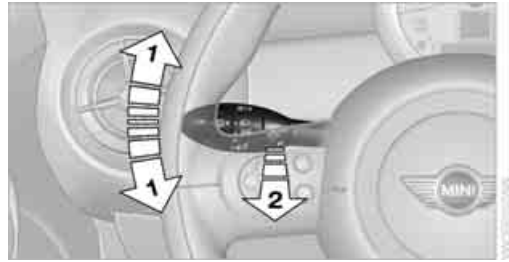

- 1 Turn signal indicator
- 2 Headlamp flasher

Using turn signals

Press the lever beyond the resistance point.

To turn off manually, press the lever to the resistance point.

▷ Unusually rapid flashing of the indicator lamp indicates that an indicator bulb has failed. ◀

Indicating a turn briefly

Press the lever as far as the resistance point for as long as you wish to indicate a turn.

Triple turn signal activation

Press the lever as far as the resistance point.

You can set whether the turn signal is to flash once or three times.

1. Switch on the ignition, refer to page 44.
2. Briefly press the button in the turn indicator lever repeatedly until "SET/INFO" is displayed.



3. Press and hold the button until the display changes.
4. Briefly press the button repeatedly until the symbol and "SET" are displayed.



5. Press and hold the button until the display changes.
6. Briefly press the button repeatedly until the display shows the illustrated symbol, arrow.

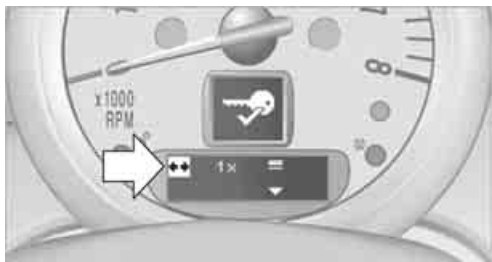

7. Press and hold the button until the display changes.

8. Briefly press the button to select:
 - ▷ 1 ×
Brief indication of a turn.
 - ▷ 3 ×
Triple turn signal.
9. Press and hold the button until the display changes. The setting is stored.

WIPER SYSTEM

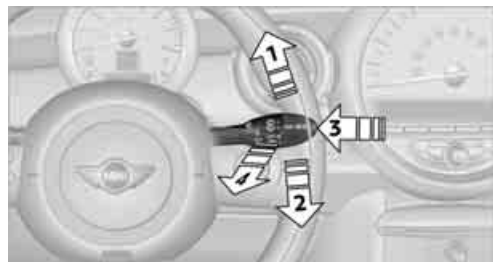

- 1 Switching on wipers
- 2 Switching off wipers or brief wipe
- 3 Activating/deactivating intermittent mode or rain sensor*
- 4 Cleaning windshield and headlamps*

Switching on wipers

Press the lever upward, arrow 1.

The lever automatically returns to its initial position when released.

Normal wiper speed

Press once.

The system switches to intermittent operation when the vehicle is stationary.

Fast wiper speed

Press twice or press beyond the resistance point. The system switches to normal speed when the vehicle is stationary.

Intermittent wipe or rain sensor*

If the car is not equipped with a rain sensor, the intermittent-wipe time is preset.

If the car is equipped with a rain sensor, the time between wipes is controlled automatically and depends on the intensity of the rainfall. The rain sensor is mounted on the windshield, directly in front of the interior rearview mirror.

Activating intermittent wipe or rain sensor

Press button, arrow 3.

! Deactivate the rain sensor before entering an automatic car wash. Failure to do so could result in damage caused by undesired wiper activation. ◀

Adjusting the sensitivity of the rain sensor

1. Switch on the ignition, refer to page 44.
2. Briefly press the button in the turn indicator lever repeatedly until "SET/INFO" is displayed.



3. Press and hold the button until the display changes.
4. Briefly press the button repeatedly until the symbol and "SET" are displayed.



5. Press and hold the button until the display changes.



6. Press the button to select the desired sensitivity.
7. Wait, or press and hold the button until the display changes. The settings are stored.

Deactivating intermittent wipe or rain sensor

Press the button again, arrow 3.

Brief wipe

Press the lever downward once, arrow 2.

Cleaning windshield and headlamps*

Pull the lever, arrow 4.

Washer fluid is sprayed onto the windshield and the wipers are operated briefly.

When the vehicle lighting system is switched on, the headlamps are cleaned at regular and appropriate intervals.

In cars equipped with an alarm system, the headlamps cannot be cleaned when the hood is open.

! Do not use the washers when the washer fluid reservoir is empty; otherwise, you will damage the washer pump.

Only use the washers if the hood has been completely closed; otherwise, the headlamp washer system* may be damaged. Do not use the washers if there is any danger that the fluid will freeze on the windshield. If you do, your vision could be obscured. For this reason, use anti-freeze. ◀

Window washer nozzles

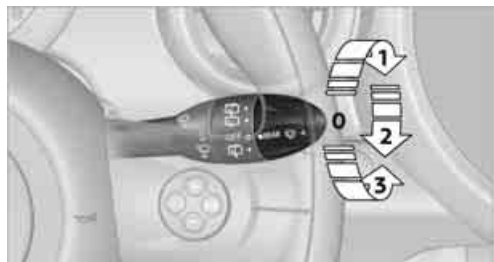

The window washer nozzles are heated automatically* while the engine is running or the ignition is switched on.

MINI: rear window wiper



- 0 Rear wipers parked
- 1 To switch on intermittent wipe :
Turn the cap to level 1.
Operation is continuous in reverse gear.

Cleaning the rear window

- 2 To clean the rear window during intermittent wipe :
Turn the cap further to level 2 and hold it there.
- 3 To clean the rear window when wipers are parked :
Turn the cap to level 3 and hold it there.

 Do not use the washers when the washer fluid reservoir is empty; otherwise, you will damage the washer pump. ◀

WASHER FLUID

 Washer fluid antifreeze is flammable. Therefore, keep it away from ignition sources, store it only in the closed original container and keep it out of reach of children; otherwise, there is a risk of personal injury. Comply with the instructions on the container. ◀

Washer fluid reservoir

 Only refill washer fluid that contains anti-freeze when the engine is cool, to avoid contact with hot engine parts. Otherwise, fluid spills constitute a fire hazard and a risk to personal safety. ◀



Fill with water and, if required, with a washer antifreeze, according to manufacturer's recommendations.

 Mix the water and antifreeze before filling the washer fluid reservoir to make sure the correct concentration is maintained. ◀

Capacity

Approx. 2.6 US quarts/2.5 liters.

With headlamp washer system:
Approx. 4.8 US quarts/4.5 liters.

CRUISE CONTROL*

The concept

Cruise control is available at vehicle speeds of at least approx. 20 mph or 30 km/h. The car then stores and maintains the speed that you specify using the button on the steering wheel.

 Do not use cruise control when driving at constant speed is prevented by adverse conditions, e.g. winding roads, dense traffic or poor road conditions due to, e.g., snow, rain, ice or loose surfaces. Otherwise, you could lose control of the vehicle and cause an accident as a result. ◀

Activating

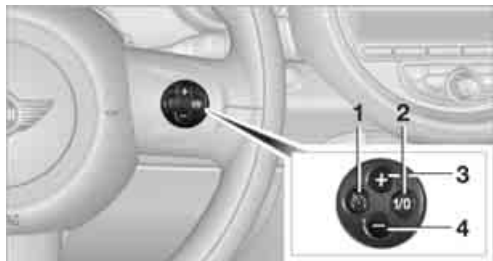

- 1 Resuming cruise control
- 2 Activating/deactivating cruise control
- 3 Maintaining, storing and increasing speed
- 4 Maintaining, storing and decreasing speed

Indicator lamp in the speedometer lights up. The cruise control system is ready and can be activated.

Activating/deactivating cruise control

Press button 2.

In addition, the system is automatically deactivated:

- ▷ When the brakes are applied
- ▷ When the clutch is depressed
- ▷ When the automatic transmission is in selection lever position N
- ▷ When the driving stability control system is active

Cruise control is not deactivated by depressing the accelerator pedal. Once the accelerator pedal is released, the stored speed is achieved again and maintained.

The stored speed is cleared when the ignition is switched off.

Maintaining current speed

Press button 3.

The system maintains and stores the current vehicle speed.

If, on a downhill grade, the engine braking effect is not sufficient, the controlled speed may be exceeded. On uphill grades vehicle speed may drop if the engine output is insufficient.

Increasing speed

Press button 3 repeatedly until the desired speed is reached. Every time you press the button, the speed increases by approx. 1 mph or 2 km/h.

Accelerating using the button

Press and hold button 3.

The vehicle accelerates without pressure on the accelerator pedal. After the button is released, the driving speed is maintained and stored.

Decreasing speed

Press button 4 repeatedly until the desired speed is reached.

The functions here are the same as for increasing the speed or accelerating, except that the speed will be decreased.

Resuming a speed stored beforehand

Press button 1.

The last speed stored is achieved again and maintained.

The stored speed is cleared when the ignition is switched off.

Display in tachometer*



Selected speed is displayed briefly.

▶ If --- mph or --- km/h is displayed briefly in the tachometer, the conditions necessary for operation may not be fulfilled. ◀

Malfunction



The warning lamp in the tachometer lights up if the system fails.

CONTROLS OVERVIEW

ODOMETER, OUTSIDE TEMPERATURE DISPLAY, CLOCK

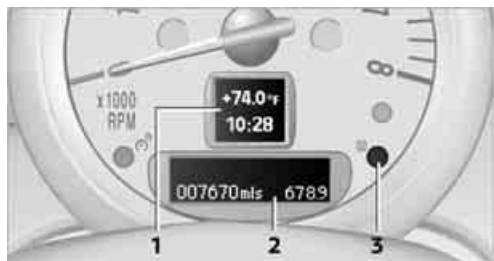

- 1 Outside temperature display and clock or current speed
- 2 Odometer and trip odometer
- 3 Resetting the trip odometer

Units of measure

Select the respective units of measure, miles or km for the odometer as well as °F or °C for the outside temperature, page 57.

Outside temperature display, time

Setting the time, refer to page 60.

Outside temperature warning

When the displayed temperature sinks to approx. +37 °F/+3 °C, a signal sounds and a warning lamp lights up. There is an increased risk of black ice.

 Black ice can also form at temperatures above +37 °F/+3 °C. Therefore, drive carefully, e.g. on bridges and sections of road in the shade; otherwise, there is an increased accident risk. ◀

Current vehicle speed

To have the current speed shown in the upper display otherwise serving for the outside temperature display and clock.

1. Press the button in the turn indicator lever repeatedly until the current speed appears in the lower display.
2. Wait for the speed display to automatically move to the upper display.

The outside temperature then appears in the lower display.

Odometer and trip odometer

Resetting the trip odometer

With the ignition switched on, press knob 3 in the tachometer.

When the vehicle is parked

To display the time, outside temperature and odometer briefly after the key is removed from the ignition lock:

Press knob 3 in the tachometer.

TACHOMETER



Never operate the engine with the needle in the red overspeed zone of the gauge. In this range, the fuel supply is interrupted to protect the engine.

COOLANT TEMPERATURE

A warning lamp will come on if the coolant, and therefore the engine, becomes too hot.

Check coolant level, refer to page 118.

FUEL GAUGE

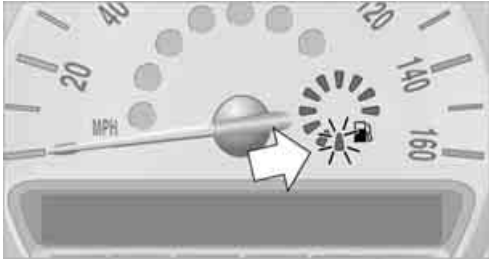

Fuel tank capacity

Approx. 13.2 US gallons/50 liters.

You can find information on refueling on page 103.

If the tilt of the vehicle varies for a longer period, when you are driving in mountainous areas, for example, the indicator may fluctuate slightly.

Reserve

Once the fuel level has fallen to the reserve zone of approx. 2.1 gallons/8 liters, the remaining indicator lamps change from orange to red, arrow. The tachometer displays the remaining cruising range. An indicator lamp comes on when the remaining range is less than approx. 30 miles/50 km.

 If the range displayed is less than 30 miles/50 km, be sure to refuel; otherwise, engine functions are not guaranteed and damage could occur. ◀

COMPUTER*

Displays in tachometer



Press the button in the turn indicator lever repeatedly to call up various items of information.

The following items of information are displayed in the order listed:

- ▷ Cruising range
- ▷ Average fuel consumption
- ▷ Current fuel consumption
- ▷ Average speed
- ▷ Current vehicle speed
- ▷ MINI Convertible: always Open Timer

To set the corresponding units of measure, refer to Formats and units of measure on page 57.

Cruising range

Displays the estimated cruising range available with the remaining fuel. The range is calculated on the basis of the way the car has been driven over the last 18 miles/30 km and the amount of fuel currently in the tank.

 If the range displayed is less than 30 miles/50 km, be sure to refuel; otherwise, engine functions are not guaranteed and damage could occur. ◀

Average fuel consumption

Calculated for the time the engine has been running.

To reset average fuel consumption: press the button in the turn indicator lever for approx. 2 seconds.

Current fuel consumption

Displays the current fuel consumption to allow you to see whether your current driving style is conducive to fuel economy with minimum exhaust emissions.

Average speed

Periods with the vehicle parked and the engine switched off are not included in the calculations of average speed.

To reset average speed: press the button in the turn indicator lever for approx. 2 seconds.

Current vehicle speed

To have the current speed shown in the upper display otherwise serving for the outside temperature display and clock.

1. Press the button in the turn indicator lever repeatedly until the current speed appears in the lower display.
2. Wait for the speed display to automatically move to the upper display.

The outside temperature then appears in the lower display of the computer.

Always Open Timer

If driving the MINI Convertible with its soft top down, the driving times are displayed digitally on the tachometer.



The following driving times are displayed:

- 1 Total driving time
- 2 Current driving time

To reset the display 2:

Press and hold the button in the turn indicator lever or the "Reset trip odometer" button, page 12, for approx. 2 seconds.

To reset the total driving time, contact your MINI dealer.

Analog to Always Open Timer

The analog Always Open Timer indicates the number of hours and minutes that you drove with the convertible top down. A maximum of 6 hours and 59 minutes can be displayed.

The total driving time is displayed digitally in the tachometer.



- 1 LED hour display
- 2 Minute display

SETTINGS AND INFORMATION

Operating principle

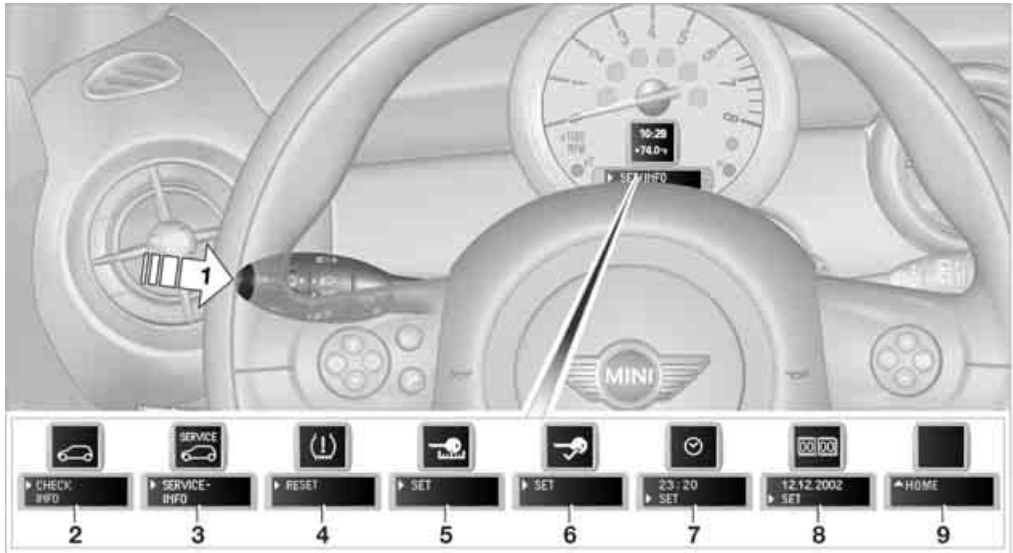

Certain settings and information are only available when the ignition is switched on, the vehicle is at a standstill and the doors are closed.

1 Button for:

- ▷ Selecting display
- ▷ Setting values
- ▷ Confirming selected display or set values
- ▷ Calling up computer information 54

2 Calling up Check Control 61

3 Displaying vehicle check 62

4 Initializing the Flat Tire Monitor 66

Resetting the Tire Pressure Monitor 68

5 Setting formats and units of measure, resetting to factory settings 58

6 Adjusting settings

- ▷ Confirmation signals when locking and unlocking the vehicle 21
- ▷ Response during unlocking procedure 19
- ▷ Automatic locking 23
- ▷ Pathway lighting 74
- ▷ Daytime running lights 75
- ▷ Triple turn signal activation 48

7 Setting the time 60

8 Setting the date 61

9 Exiting the menu

Exiting displays



1. Briefly press the button in the turn indicator lever repeatedly until "HOME" is displayed.
2. Press the button for a longer period.

The display again shows the outside temperature and the time.

Displays are also exited if no entries are made for approx. 8 seconds.

Next setting or item of information



1. While in a setting or information item, briefly press the button in the turn indicator lever repeatedly until "NEXT" is displayed.
2. Press the button for a longer period.

The display changes directly to the next setting or item of information.

FORMATS AND UNITS OF MEASURE

To set the formats and units of measure. The settings are stored for the remote control currently in use, refer also to Personal Profile on page 18.

1. Switch on the ignition, refer to page 44.
2. Briefly press the button in the turn indicator lever repeatedly until "SET/INFO" is displayed.



3. Press and hold the button until the display changes.
4. Briefly press the button repeatedly until the symbol and "SET" are displayed.



5. Press and hold the button until the display changes.
6. Briefly press the button repeatedly until the display shows the illustrated symbol, arrow.

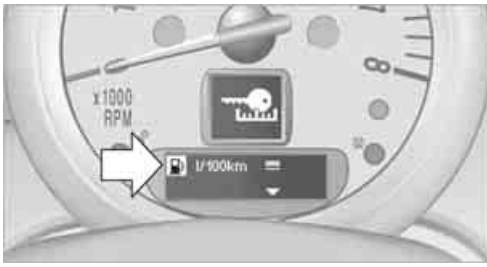

- ▷ Fuel consumption: l/100 km, mpg, km/l*
- ▷ Distance covered: mls, km
- ▷ Time: 12h, 24h mode
- ▷ Date: day.month dd.mm, month/day mm/dd
- ▷ Temperature: °F, °C

7. Press and hold the button until the display changes.
8. Press the button briefly to change the format or unit of measure.
9. Press and hold the button until the display changes. The settings are stored.

Resetting to factory settings

The settings for formats and units of measure can be reset to the factory settings. The settings are stored for the remote control currently in use, refer also to Personal Profile on page 18.

1. Briefly press the button in the turn indicator lever repeatedly until "SET/INFO" is displayed.



2. Press and hold the button until the display changes.

3. Briefly press the button repeatedly until the symbol and "SET" are displayed.



4. Press and hold the button until the display changes.
5. Briefly press button repeatedly until "RESET" is displayed.



6. Press and hold the button until the display changes to the first setting. The settings are reset.

SERVICE REQUIREMENTS



The remaining driving distance and the date of the next scheduled service are briefly displayed immediately after you start the engine or switch on the ignition.

 The extent of service work required can be read out from the remote control by your MINI dealer. ◀

Displaying vehicle check

For certain maintenance operations, you can view the respective distance remaining or due date individually in the tachometer.

1. Switch on the ignition, refer to page 44.
2. Briefly press the button in the turn indicator lever repeatedly until "SET/INFO" is displayed.



3. Press and hold the button until the display changes.
4. Briefly press the button repeatedly until the corresponding symbol and "SERVICE INFO" are displayed.



5. Press and hold the button until the display changes.
6. Briefly press the button to display the individual service items, refer to the following information.

Possible displays

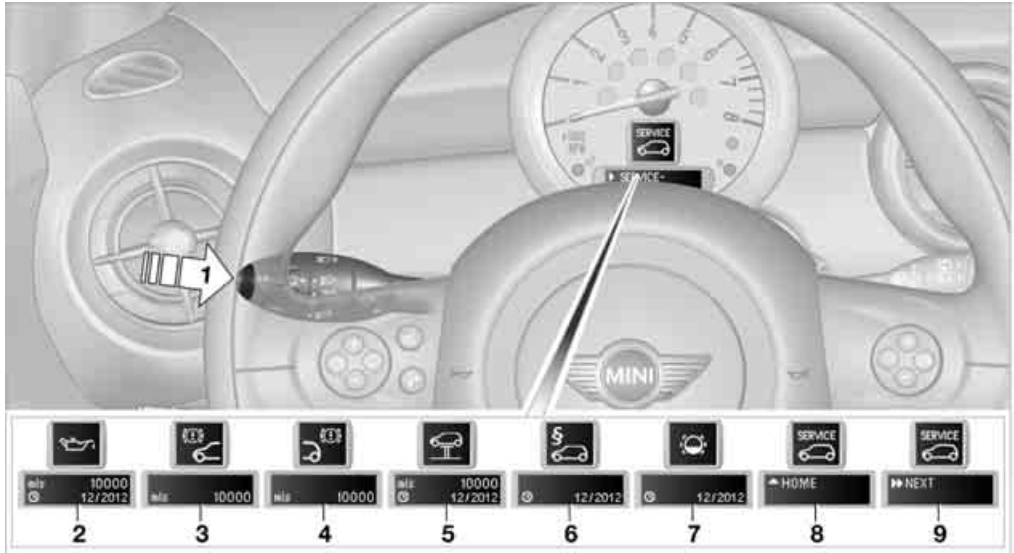

- 1 Button for selecting information
- 2 Engine oil
- 3 Front brakes
- 4 Rear brakes
- 5 Vehicle check
- 6 Roadworthiness test
- 7 Brake fluid
- 8 Exit display 57
- 9 Next setting or item of information 57

More information on the MINI Maintenance System can be found on page 119.

CLOCK

Setting the time

To set the 12h/24h mode, refer to Formats and units of measure on page 57.

1. Briefly press the button in the turn indicator lever repeatedly until "SET/INFO" is displayed.



2. Press and hold the button until the display changes.
3. Briefly press the button repeatedly until the symbol and "SET" are displayed.



4. Press and hold the button until the display changes.
5. Press the button to set the hours.

6. Wait for the display to change to minutes.
7. Press the button to set the minutes.
8. Wait for the display to change.
The settings are stored.

DATE

Setting the date

To set the dd/mm or mm/dd date format, refer to Formats and units of measure on page 57.

1. Briefly press the button in the turn indicator lever repeatedly until "SET/INFO" is displayed.



2. Press and hold the button until the display changes.
3. Briefly press the button repeatedly until the symbol and "SET" are displayed.



4. Press and hold the button until the display changes.
5. Press the button to set the day of the month.
6. Wait for the display to change to month.
7. Set the month and year in the same way.
8. Wait for the display to change.
The settings are stored.

CHECK CONTROL

The concept

The Check Control monitors vehicle functions and alerts you to any malfunctions in the systems monitored. Check Control messages involve indicator or warning lamps in the displays and, in some circumstances, an acoustic signal. To adjust the volume of the signal, refer to the Owner's Manual for Radio.



Indicator and warning lamps can light up in various combinations and colors in the indicator areas 1 and 2.

What to do in case of a malfunction

The meaning of each lamp in the event of a malfunction and tips on how to respond are listed starting on page 140.

Hiding Check Control messages

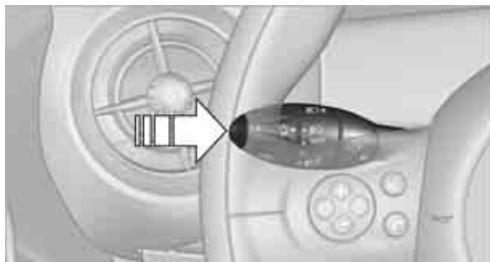

Press the button in the turn indicator lever.

Some Check Control messages are displayed until the malfunctions have been rectified. They cannot be hidden. If several malfunctions occur at the same time, they are displayed in succession.

Other Check Control messages are automatically hidden after approx. 20 seconds, but remain stored.



⚠ This symbol indicates that Check Control messages have been stored. Check Control messages can be viewed whenever it is convenient.

Viewing stored Check Control messages

Stored Check Control messages can only be displayed if the driver's door is closed.

1. Briefly press the button in the turn indicator lever repeatedly until "SET/INFO" is displayed.



2. Press and hold the button until the display changes.
3. Briefly press the button repeatedly until the corresponding symbol and "CHECK INFO" are displayed.



4. Hold the button down.
If there are no Check Control messages, then "CHECK OK" is displayed.
If a Check Control message has been stored, the corresponding message is displayed.
5. Briefly press the button to check for other messages.

TECHNOLOGY FOR DRIVING COMFORT AND SAFETY

PARK DISTANCE CONTROL PDC*

The concept

PDC assists you with parking backwards. Acoustic signals warn you of the presence of an object behind the vehicle. To measure the distance, there are four ultrasonic sensors in either bumper.

However, an acoustic warning does not sound until an object is approx. 24 in/60 cm from the corner sensors, or approx. 5 ft/1.50 m from the center sensors.

 PDC is a parking aid that can indicate objects when they are approached slowly, as is usually the case when parking. Avoid approaching an object at high speed; otherwise, physical circumstances may lead to the system warning being issued too late. ◀

Automatic mode

With the engine running or the ignition switched on, the system is activated automatically after approx. 1 second when you engage reverse gear or move the automatic transmission selector lever to position R. Wait this short period before driving.

Acoustic signals

As the distance between vehicle and object decreases, the intervals between the tones become shorter. If the distance to the nearest object falls to below roughly 1 ft/30 cm, then a continuous tone sounds.

If the distance remains constant, e.g. when driving parallel to a wall, the acoustic signal stops after approx. 3 seconds.

Adjustments

The volume of the acoustic signals can be adjusted, refer to the Owner's Manual for Radio.

Malfunction



Indicator lamp comes on: PDC has failed. Have the system checked.

To avoid this problem, keep the sensors clean and free of ice or snow in order to ensure that they will continue to operate effectively. When using a high-pressure cleaner, do not direct the jet toward the sensors for lengthy periods and only spray from a distance of at least 4 in/10 cm.

System limitations



Even with PDC, final responsibility for estimating the distance between the vehicle and any obstructions always remains with the driver. Sensors, too, have blind spots in which objects cannot be detected. Moreover, ultrasonic detection can reach its physical limits with objects such as trailer tow bars and couplings, thin and wedge-shaped objects, etc. Low objects already indicated, such as curbs, may enter the sensors' blind spots before or after a continuous audible signal is given. Higher, protruding objects, such as wall ledges, may not be detectable. Therefore, always drive cautiously; otherwise, there is a risk of personal injury or property damage. Loud sound sources outside or inside the car can drown out the PDC signal. ◀

DRIVING STABILITY CONTROL SYSTEMS

Your MINI has a number of systems that help to maintain the vehicle's stability even in adverse driving conditions.



The laws of physics cannot be repealed, even with driving stability control systems. An appropriate driving style always remains the responsibility of the driver. Therefore do not reduce the additional safety margin by engaging in hazardous driving thereby running the risk of an accident. ◀

Antilock Brake System ABS

ABS prevents locking of the wheels during braking. Safe steering response is maintained even during full braking. Active safety is thus increased.

Braking safely, refer to page 93.

Among others, ABS includes the following functions:

- ▷ Cornering Brake Control CBC
- ▷ Electronic brake-force distribution EBV
- ▷ Brake Assist

Cornering Brake Control CBC

Driving stability and steering characteristics are further enhanced while braking in turns or during a lane change.

Electronic brake-force distribution EBV

The system controls the brake pressure in the rear wheels to ensure stable braking behavior.

Brake Assist

Rapidly depressing the brake causes this system to automatically develop maximum braking force. Thus, the system helps keep braking distance to a minimum. At the same time, all the benefits provided by ABS are exploited.

Do not reduce the pressure on the brake for the duration of the full braking application.

Dynamic Stability Control DSC

DSC prevents the driving wheels from losing traction when you pull away from rest or accelerate. The system also recognizes unstable driving conditions, for example if the rear of the car is about to swerve or if momentum is acting at an angle past the front wheels. In these cases, DSC helps the vehicle maintain a safe course within physical limits by reducing engine output and through braking actions at the individual wheels.

DSC also encompasses the following functions:

- ▷ Antilock Brake System ABS
- ▷ Electronic brake-force distribution EBV
- ▷ Brake Assist

- ▷ Cornering Brake Control CBC
- ▷ Hill Assist

Deactivating DSC

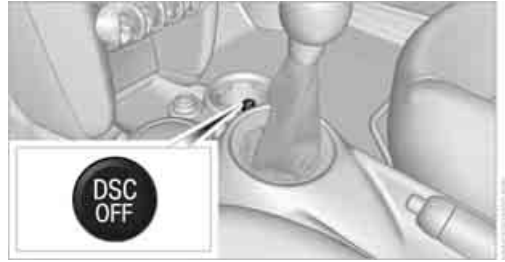

Press the button repeatedly until the DSC indicator lamps come on. DSC is deactivated. Stabilizing and propulsion promoting actions are no longer executed.

When driving with snow chains or to 'rock free' in snow, it can be helpful to switch off DSC for a brief period.

To increase vehicle stability, activate DSC again as soon as possible.

Activating DSC

Press the button again: the DSC indicator lamps go out.

For better control



If the indicator lamp flashes:
The DSC controls the driving and braking forces.



If the indicator lamps are on:
DSC is deactivated.



Dynamic Traction Control DTC*

DTC is a type of DSC that is propulsion optimized for special road conditions such as uncleared snowy roads. The system ensures maximum propulsion though with restricted driving stability. You therefore need to drive with suitable caution.

In the following exceptional situations, it can be useful to briefly activate DTC:

- ▷ when driving on snow-covered inclines, in slush, or on uncleared snowy roads
- ▷ when rocking the vehicle free, driving out of deep snow or on loose surfaces
- ▷ when driving with snow chains

Activating DTC

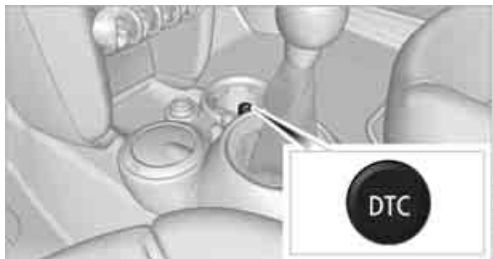

Press the button: the DTC indicator lamps come on.

For better control



If the indicator lamp flashes: DTC controls the driving and braking forces.

DTC

If the indicator lamps are on: DTC is activated.



Deactivating DTC

Press the button again: the DTC indicator lamps go out.

Deactivating both DTC and DSC

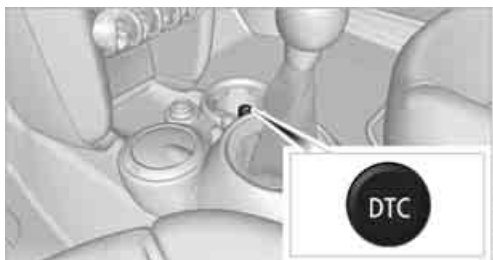

Press the button for at least 3 seconds: the DSC indicator lamps in the display elements come on. The Dynamic Traction Control DTC and

Dynamic Stability Control DSC are both deactivated. There will be no more stabilizing interventions.

Interventions (differential lock*) in braking occur to improve propulsion when drive wheels are rotating unevenly, even when the DSC is deactivated.

Activating DSC

Press the button again: the indicator lamps go out.

Hill Assist

Hill Assist aids you in comfortably driving off on inclines. It is not necessary to use the parking brake for this.

1. Hold the MINI with the brake.
2. Release the brake and immediately drive off.

Hill Assist holds the car in place for approx. 2 seconds after the brake is released.



Depending on the load and gradient, the vehicle can roll backward slightly during this period. After you release the brake, immediately start driving since the Hill Assist only holds the vehicle for about 2 seconds, and it will start to roll backwards. ◀

SPORT BUTTON*

Pressing the button causes your MINI to respond even more sportily.

- ▷ Engine responds more spontaneously to movements of the accelerator.
- ▷ Steering response is more direct.
- ▷ Cooper S, John Cooper Works: the engine sounds more sporty in coasting mode.

With automatic transmission:

- ▷ More rapid gear shifting in Sport program.

Activating the system



Press the SPORT button.
The LED lights up.

SPORT is briefly displayed in the tachometer.

Deactivating the system

- ▷ Press the SPORT button again.
- ▷ Switch off the engine.

FLAT TIRE MONITOR FTM*

The concept

The Flat Tire Monitor detects pressure loss in a tire by comparing the rotating speeds of the individual tires while moving.

If a tire loses pressure, its rolling circumference changes, and this in turn alters the speed of rotation. This change is detected and is reported as a flat tire.

Functional requirement

In order to assure the reliable reporting of a flat tire, the system must be initialized for the correct tire inflation pressure.

- ▷ Each time you correct the pressure in a tire, or change a wheel or tire, the system must be reinitialized. ◀

System limitations

The Flat Tire Monitor is unable to warn the driver of sudden, severe tire damage caused by external factors, nor can it identify the gradual loss of pressure that will inevitably occur in all four tires over a lengthy period of time.

In the following situations, the system could be delayed or malfunction:

- ▷ System has not been initialized
- ▷ Driving on snowy or slippery road surface
- ▷ Performance-oriented style of driving: slip in the drive wheels, high lateral acceleration
- ▷ Snow chains are attached

When the vehicle is driven with a space-saver spare tire*, page 133, the Flat Tire Monitor cannot function.

Initializing the system

- ▷ The initialization is completed during driving, which can be interrupted at any time. When driving resumes, the initialization is continued automatically.

Do not initialize the system if you are driving with snow chains or a space-saver spare tire*. ◀

Using the button in the turn indicator lever

1. Start the engine, but do not start driving.
2. Briefly press the button in the turn indicator lever repeatedly until "SET/INFO" is displayed.





3. Press and hold the button until the display changes.

- Briefly press the button repeatedly until the corresponding symbol and "RESET" are displayed.



- Press and hold the button until the display changes.
- Start driving.
Initialization is completed while the car is on the move, without any feedback.

Indication of a flat tire

 The warning lamps come on in yellow and red. An acoustic signal also sounds.  There is a flat tire or substantial loss of tire pressure.

- Reduce speed and stop the vehicle with caution. Avoid sudden braking and steering maneuvers.
- Check whether your vehicle is equipped with normal tires or run-flat tires.

 The symbol identifying run-flat tires is a circle with the letters RSC on the sidewall, refer to Run-flat tires, page 114. ◀

Normal tires

- Determine which tire is damaged.
 If this cannot be determined, contact your MINI dealer. ◀
- Repair the flat tire, refer to page 129, or change the damaged tire, refer to page 132.

Run-flat tires*

- Cautiously reduce speed to below 50 mph or 80 km/h. Avoid sudden braking and steering maneuvers. Do not exceed a speed of 50 mph or 80 km/h.

 Do not continue driving if the vehicle is not equipped with run-flat tires, page 114; otherwise, a serious accident could result. ◀

- At the next opportunity, check the air pressure in all four tires.

 If all four tires are inflated to the correct pressures, the Flat Tire Monitor might not have been initialized. The system must then be initialized. ◀

- In the event of complete tire pressure loss, 0 psi/0 kPa, you can estimate the possible distance for continued driving on the basis of the following guidelines:

- ▷ With a light load:
1 to 2 persons without luggage:
approx. 155 miles/250 km
- ▷ With a medium load:
2 persons, cargo bay full, or 4 persons without luggage:
approx. 94 miles/150 km
- ▷ With a full load:
4 persons, load compartment full:
approx. 30 miles/50 km

 Drive cautiously and do not exceed a speed of 50 mph or 80 km/h; otherwise, an accident may occur. In the event of pressure loss, vehicle handling changes. This includes reduced tracking stability in braking, extended braking distance and altered natural steering characteristics.

If unusual vibration or loud noises occur during the journey, this may be an indication that the damaged tire has finally failed. Reduce the vehicle speed and stop as soon as possible. Otherwise, sections of the tire may come loose and cause accidents. Do not continue driving and contact your MINI dealer. ◀

TIRE PRESSURE MONITOR TPM*

The concept

TPM checks the tire pressure in the four mounted tires during driving. The system notifies you if there is a significant loss of pressure in one or more tires.

Functional requirement

In order to assure the reliable reporting of a flat tire, the system must be reset while all tire inflation pressures are correct.

Always use wheels with TPM electronics. Otherwise, the system may malfunction.

▶ Each time a tire inflation pressure has been corrected or a wheel or tire has been changed, reset the system. ◀

System limitations

⚠ TPM cannot warn you in advance of sudden severe tire damage caused by outside influences. ◀

The system does not work correctly if it has not been reset; for example, a flat tire may be indicated even though the tire inflation pressures are correct.

The system is inactive and cannot indicate a flat tire if a wheel without TPM electronics, such as a compact spare wheel*, has been mounted, or if TPM is temporarily malfunctioning due to other systems or devices using the same radio frequency.

Resetting the system

▶ Each time a tire inflation pressure has been corrected or a wheel or tire has been changed, reset the system. ◀

Using the button in the turn indicator lever

1. Start the engine, but do not start driving.
2. Briefly press the button in the turn indicator lever repeatedly until "SET/INFO" is displayed.



3. Press and hold the button until the display changes.
4. Briefly press the button repeatedly until the symbol for Tire Pressure Monitor and "ACTIVE" are displayed. The Tire Pressure Monitor can be reset by selecting "RESET".



5. Press and hold the button until "RESETTING" is displayed.



6. Start driving. After driving a few minutes, the set inflation pressures in the tires are accepted as the target values to be monitored. The system reset is completed during your drive, and can be interrupted at any time. When driving resumes, the reset is continued automatically. The indicator lamp goes out after the system reset is completed.

Message for low tire inflation pressure



The warning lamps come on in yellow and red. An acoustic signal also sounds. There is a flat tire or substantial loss of tire pressure.



1. Reduce speed and stop the vehicle with caution. Avoid sudden braking and steering maneuvers.
2. Check whether your vehicle is equipped with normal tires or run-flat tires.



The symbol identifying run-flat tires is a circle with the letters RSC on the sidewall, page 114. ◀

Normal tires

1. Determine which tire is damaged.
 - ▶ If this cannot be determined, contact your MINI dealer. ◀
2. Repair the flat tire or change the damaged tire, refer to page 132.

Run-flat tires*

1. Cautiously reduce speed to below 50 mph/80 km/h. Avoid sudden braking and steering maneuvers. Do not exceed a speed of 50 mph/80 km/h.



Do not continue driving if the vehicle is not equipped with run-flat tires; otherwise, a serious accident could result. ◀

2. In the event of complete tire pressure loss, 0 psi/0 kPa, you can estimate the possible distance for continued driving on the basis of the following guidelines:
 - ▶ With a light load:
1 to 2 persons without luggage:
approx. 155 miles/250 km
 - ▶ With a medium load:
2 persons, cargo bay full, or 4 persons without luggage:
approx. 94 miles/150 km
 - ▶ With a full load:
4 persons, load compartment full:
approx. 30 miles/50 km



Drive cautiously and do not exceed a speed of 50 mph/80 km/h; otherwise, an accident may occur. In the event of pressure loss, vehicle handling changes. This includes reduced tracking stability in braking, extended braking distance and altered natural steering characteristics.

If unusual vibration or loud noises occur during the journey, this may be an indication that the damaged tire has finally failed. Reduce the vehicle speed and stop as soon as possible. Otherwise, sections of the tire may come loose and cause accidents. Do not continue driving and contact your MINI dealer. ◀

Malfunxion



The small warning lamp flashes in yellow and then lights up continuously; the larger warning lamp comes on in yellow. No punctures can be detected.



This type of message is shown in the following situations:

- ▶ If there is a malfunction. Have the system checked.
- ▶ If a wheel without TPM electronics has been mounted.
- ▶ If TPM is temporarily malfunctioning due to other systems or devices using the same radio frequency.

Message for unsuccessful system reset



Both warning lamps come on in yellow.



The system is not reset after a tire has been changed, for example.

Check the tire inflation pressure and reset the system, page 68.

Declaration according to NHTSA/ FMVSS 138 Tire Pressure Monitoring Systems

Each tire, including the spare, should be checked monthly when cold and inflated to the inflation pressure recommended by the vehicle manufacturer on the vehicle placard or tire inflation pressure label. If your vehicle has tires of a different size than the size indicated on the vehicle placard or tire inflation pressure label, you should determine the proper tire inflation pressure for those tires. As an added safety feature, your vehicle has been equipped with a tire pressure monitoring system TPMS that illuminates a low tire pressure telltale when one or more of your tires are significantly underinflated.

Accordingly, when the low tire pressure telltale illuminates, you should stop and check your tires as soon as possible, and inflate them to the proper pressure. Driving on a significantly underinflated tire causes the tire to overheat and can lead to tire failure. Underinflation also reduces fuel efficiency and tire tread life, and may affect the vehicle's handling and stopping ability. Please note that the TPMS is not a substitute for proper tire maintenance, and it is the driver's responsibility to maintain correct tire pressure, even if underinflation has not reached the level at which the TPMS low tire pressure telltale illuminates.

The TPMS malfunction indicator is combined with the low tire pressure telltale. When the system detects a malfunction, the telltale will flash for approximately one minute and then remain continuously lit. This sequence will continue upon subsequent vehicle startups as long as the malfunction exists. When the malfunction indicator is illuminated, the system may not be able to detect or signal low tire pressure as intended. TPMS malfunctions may occur for a variety of reasons, including the installation of replacement or alternate tires or wheels on the vehicle that prevent the TPMS from functioning properly. Always check the TPMS malfunction telltale after replacing one or more tires or wheels on your vehicle to ensure that the replacement or alternate tires and wheels allow the TPMS to continue to function properly.

AIRBAGS

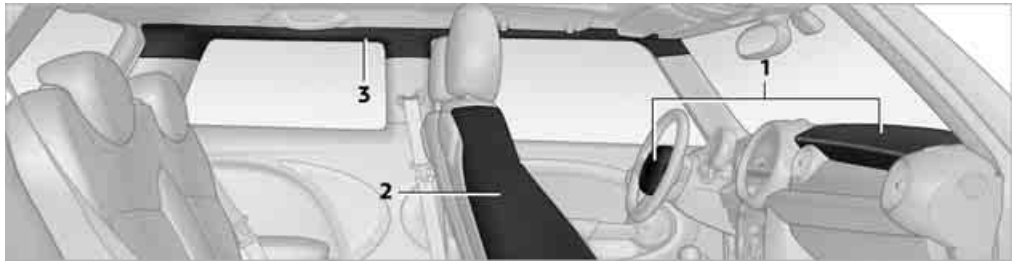

The following airbags are located under the marked covers:

MINI:

- 1 Front airbags
- 2 Side airbags in backrests
- 3 Head airbags at the front and rear

Protective effect

 Observe the instructions on page 35 to ensure the best possible personal protection. ◀

The front airbags help protect the driver and front passenger by responding to frontal impacts in which safety belts alone cannot provide adequate restraint. When needed, the head and side airbags help provide protection in the event of side impact. The relevant side airbag supports the side upper body area. The head airbag supports the head.

The side/head airbag in the MINI Convertible protects the head during impact.

The airbags are designed to not be triggered in every type of collision, e.g. not in minor accidents, certain rollover situations or rear impacts.

 Do not apply adhesive materials to the cover panels of the airbags, cover them or modify them in any other way.

Keep the dashboard and window on the passenger side free from obstruction, i.e. do not cover it with adhesive film or coverings, and do not affix any holders such as for a navigation device or a mobile phone.

Do not attach seat covers, cushions or other objects not specifically approved for seats with integral side airbags to the front seats. Do not

MINI Convertible:

- 1 Front airbags
- 2 Side/head airbags in the backrests

hang items of clothing such as coats or jackets over the backrests. Do not attempt to remove the airbag retention system from the vehicle. Do not modify the individual components of the system or its wiring in any way. This includes the upholstered covers on the steering wheel, instrument panel, seats and roof posts, as well as the sides of the roof lining. Do not attempt to remove or dismantle the steering wheel.

Do not touch the individual components immediately after the system has been triggered, because there is a danger of burns.

In the event of malfunctions, deactivation, or triggering of the airbag restraint system, have the testing, repair, removal, and disposal of airbag generators executed only by a MINI dealer or a workshop that works according to repair procedures of the manufacturer of your MINI with correspondingly trained personnel and has the required explosives licenses. Otherwise, unprofessional attempts to service the system could lead to failure in an emergency or undesired airbag activation, either of which could result in personal injury. ◀

Warning notices and information about the airbags can also be found on the sun visors.

Automatic deactivation of the front passenger airbags

An analysis of the impression in the front passenger seat cushion determines whether and how the seat is occupied. The front and side airbags for the front passenger are activated or deactivated by the system accordingly.

▶ The indicator lamp above the interior rear-view mirror shows the current status of the front passenger airbags, deactivated or activated, refer to Status of front passenger airbags below. ◀

⚠ Before transporting a child on the front passenger seat, read the safety precautions and handling instructions under Transporting children safely, page 41.

The front and side airbags can also be deactivated by adolescents and adults sitting in certain positions; the indicator lamp for the front passenger airbags comes on. In such cases, the passenger should change his or her sitting position so that the front passenger airbags are activated and the indicator lamp goes out. If the desired airbag status cannot be achieved by changing the sitting position, transport the relevant passenger on a rear seat. Do not attach covers, cushions, ball mats or other items to the front passenger seat unless they are specifically recommended by the manufacturer of your MINI. Do not place any items under the seat which could press against the seat from below. Otherwise, a correct analysis of the seat cushion is not ensured. ◀

Status of front passenger airbags

MINI:



MINI Convertible:

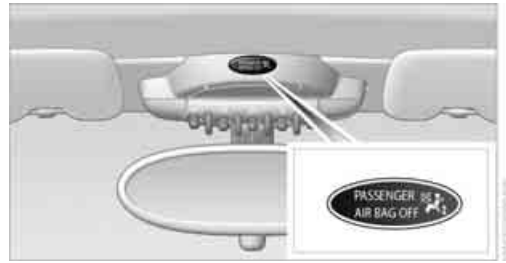

The indicator lamp for the front passenger airbags shows the functional status of the front passenger's front and side airbags in accordance with whether and how the front passenger seat is occupied. The indicator lamp shows whether the front passenger airbags are activated or deactivated.

▶ The indicator lamp comes on as intended when a child in a specially designated child restraint system is detected on the seat. The front and side airbags for the front passenger are not activated.

▶ Most child seats are detected by the system. This particularly applies to child seats that were required by the NHTSA at the time of manufacture of the vehicle. After installing a child seat, check that the indicator lamp for the front passenger airbags comes on. It indicates that the child seat has been detected and that the front passenger airbags are deactivated. ◀

▶ The indicator lamp does not come on as long as a person of sufficient size and in a correct sitting position is detected on the seat. The front and side airbags for the front passenger are activated.

▶ The indicator lamp does not come on if the seat is empty. The front and side airbags for the front passenger are not activated.

Operational readiness of airbag system



As of radio readiness, page 44, the warning lamp comes on briefly to indicate that the entire airbag system and the belt tensioners are operational.

Airbag system malfunction

- ▷ The warning lamp does not come on when radio readiness or the ignition is switched on.
- ▷ The warning lamp stays lit continuously.

 In the event of a fault in the airbag system, have it checked without delay; otherwise, there is the risk that the system will not function as intended even if a severe accident occurs. ◀

MINI CONVERTIBLE: ROLLOVER PROTECTION SYSTEM

The rollover system is automatically activated during an accident or dangerous driving situation, during extreme tilt of the longitudinal axis, or during loss of ground contact. The roll bar located behind the rear seat headrest is projected within a fraction of a second.

In addition to the reinforced windshield frame, the rollover protection system ensures the necessary head clearance for all occupants of the vehicle.

 Never block the travel path of the rollover protection system with any objects. Always wear your safety belt, it protects you in a minor car accident and, depending on the severity of the accident, the seat belt tensioner

and the multilevel airbag system will protect you. ◀

Lowering

If the rollover protection system releases accidentally, have your MINI Service check it.

 If the rollover protective system is extended, do not operate the convertible top.

Never attempt to modify the individual components or the electrical wiring of the rollover protective system.

Have the necessary work on the rollover protection system of your MINI only carried out by an authorized MINI dealer.

Faulty repair may lead to the failure of the system or malfunctions.

Check the system regularly and in order to ensure a long service life of all functions, it is mandatory to maintain the service intervals, refer to page 58. ◀

LAMPS

PARKING LAMPS/LOW BEAMS

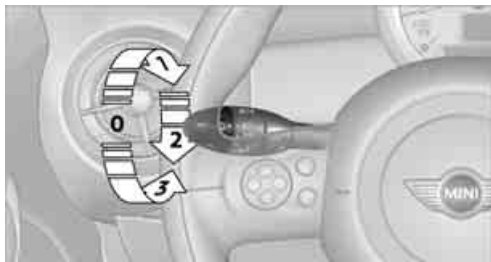

- 0** Lamps off and daytime running lights
- 1** Parking lamps and daytime running lights
- 2** Low-beam headlamps and welcome lamps
- 3** Automatic headlamp control*, daytime running lights and welcome lamps

When you open the driver's door with the ignition switched off, the exterior lighting is automatically switched off if the light switch is in position **0**, **2** or **3**.

Switch on the parking lamps if necessary, switch position **1**.

Parking lamps

Turn the light switch to position **1**.

The front, rear and side vehicle lighting is switched on.

Activation of lights on one side of the vehicle for parking, page [76](#).

 The parking lamps will discharge the battery. Therefore, do not leave them on for unduly long periods of time; otherwise, the battery might not have enough power to start the engine. ◀

Low beams

Turn the light switch to position **2**.

The low beams come on when the ignition is on.

Automatic headlamp control*

When the switch is in position **3**, the low beams are switched on and off automatically depending on ambient light conditions, e.g. in a tunnel, in twilight, or if there is precipitation.

The headlamps may also come on when the sun is sitting low on a blue sky.

When driving into tunnels with bright overhead lights, there may be a delay before the headlamps come on.

The low beams remain switched on independent of the ambient lighting conditions when you switch on the fog lamps*.

If the daytime running lights are activated, page [75](#), the low beams are always switched on with the light switch in position **3** and the ignition on. The exterior lamps are automatically switched off after the vehicle is parked.

 The automatic headlamp control cannot serve as a substitute for your personal judgment in determining when the lamps should be switched on in response to ambient lighting conditions. For example, the system cannot detect fog or hazy weather. To avoid safety risks, you should respond to these kinds of low-visibility situations by switching the headlamps on manually. ◀

Welcome lamps

If you leave the light switch in the low beam or automatic headlamp control position when you switch off the ignition, the parking lamps and interior lamps come on for a certain time as soon as the vehicle is unlocked.

Pathway lighting

If you activate the headlamp flasher after switching off the ignition with the lamps switched off, the low beams come on and remain on for a certain time.

The setting is stored for the remote control in use, refer to Personal Profile, page [18](#).

Setting the duration or deactivating the function

1. Switch on the ignition, refer to page 44.
2. Briefly press the button in the turn indicator lever repeatedly until "SET/INFO" is displayed.



3. Press and hold the button until the display changes.
4. Briefly press the button repeatedly until the symbol and "SET" are displayed.



5. Press and hold the button until the display changes.
6. Briefly press the button repeatedly until the display shows the illustrated symbol.

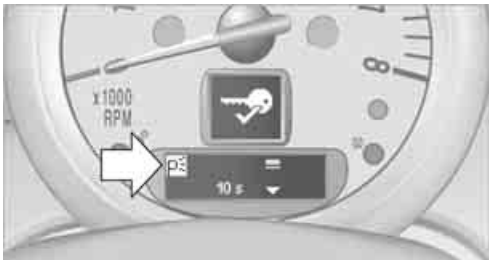

7. Press and hold the button until the display changes.

8. Briefly press the button to select:
 - ▷ **0 s**
The function is deactivated.
 - ▷ **10 s ... 240 s**
Select the corresponding duration, e.g. to 40 seconds.
9. Press the button for a longer period.
The setting is stored.

Daytime running lights*

The light switch can remain in the lamps off, parking lamps or automatic headlamp control* position.

In the lamps off position, the exterior lighting is automatically switched off after the vehicle is parked. In the parking lamps position, the parking lamps will stay on after the ignition is switched off.

Switch on the parking lamps separately if needed.

Activating/deactivating daytime running lights

The setting is stored for the remote control in use, refer to Personal Profile, page 18.

1. Switch on the ignition, refer to page 44.
2. Briefly press the button in the turn indicator lever repeatedly until "SET/INFO" is displayed.



3. Press and hold the button until the display changes.

- Briefly press the button repeatedly until the symbol and "SET" are displayed.



- Press and hold the button until the display changes.
- Briefly press the button repeatedly until the display shows the illustrated symbol, arrow.

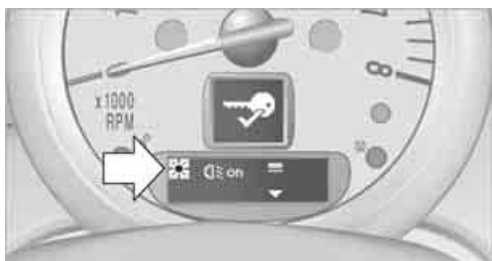

- Press and hold the button until the display changes.
- Briefly press the button to select:
 - ▷ on
Daytime running lights activated.
 - ▷ off
Daytime running lights deactivated.
- Press the button for a longer period. The setting is stored.

HIGH BEAMS/ROADSIDE PARKING LAMPS

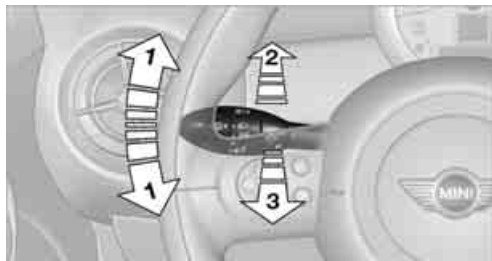

- Turn signal indicators/roadside parking lamps*
- Switching on high beams
- Switching off high beams/headlamp flasher

Roadside parking lamps, left or right*

The vehicle can be illuminated on one side for parking. Comply with local regulations when doing so.

Switching on

After parking the vehicle, press the lever up or down, arrow 1.

The roadside parking lamps drain the battery. Therefore, do not leave them on for unduly long periods of time; otherwise, the battery might not have enough power to start the engine. ◀

Switching off

Press the lever up or down to the pressure point.

FOG LAMPS*

MINI



- 1 Fog lamps*
- 2 Rear fog lamp*

Press the respective switch to turn the lamps on/off.

MINI Convertible

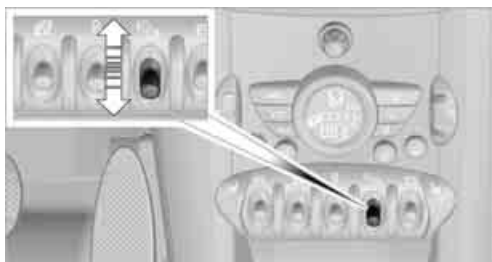

- ▷ Turn on fog lamps:
Press the button upwards.
- ▷ Turn on rear fog lamp:
Press the button downwards.

When turning the lamps off, push the respective button again upwards or downwards.

Fog lamps*

The parking lamps or low beams must be switched on for the fog lamps to operate. The green indicator lamp comes on when the fog lamps are switched on.

Depending on your vehicle's equipment, the fog lamps are switched off when you activate the headlamp flasher or switch on the high beams.

- ▷ If the automatic headlamp control is activated, the low beams will come on automatically when you switch on the fog lamps. ◀

Rear fog lamp*

The low beams or parking lamps with fog lamps must be switched on. The yellow indicator lamp comes on when the rear fog lamp is switched on.

INSTRUMENT LIGHTING

You can adjust the brightness of the instrument lighting only when the parking lamps or the low beams are on.



Increasing brightness

Press and hold the button until the desired brightness is reached.

Reducing brightness

Press the button briefly.

The brightness decreases every time the button is pressed briefly.

INTERIOR LAMPS

The interior lamps, the footwell lamps* and the cargo bay lamp are controlled automatically.

- ▷ To avoid draining the battery, all lamps inside the car are switched off about 8 minutes after the ignition is switched off, refer to Start/stop button on page 44. ◀

Switching interior lamps on/off manually

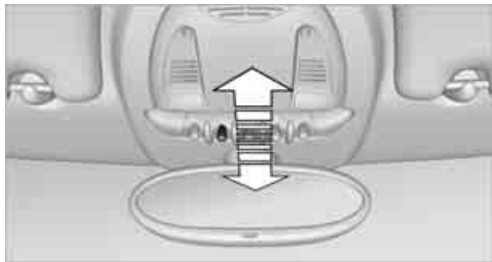

To switch the interior lamps on/off.

Press the switch.

To switch off the interior lamps permanently, press the button for about 3 seconds.

- ▷ Press the switch toward the rear. The color changes in stages, ultimately to blue.

Intermediate settings and colors are possible.

Reading lamps*

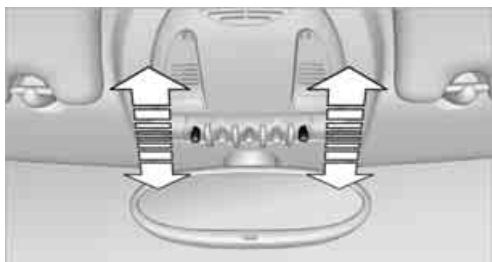

To switch the reading lamps on and off.

Press the switch.

Ambient lighting*

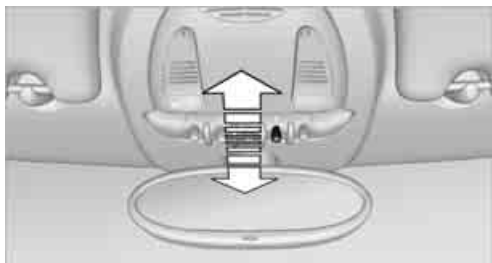

The color of the ambient lighting can be changed.

- ▷ Press the switch forward. The color changes in stages, ultimately to orange.

CLIMATE

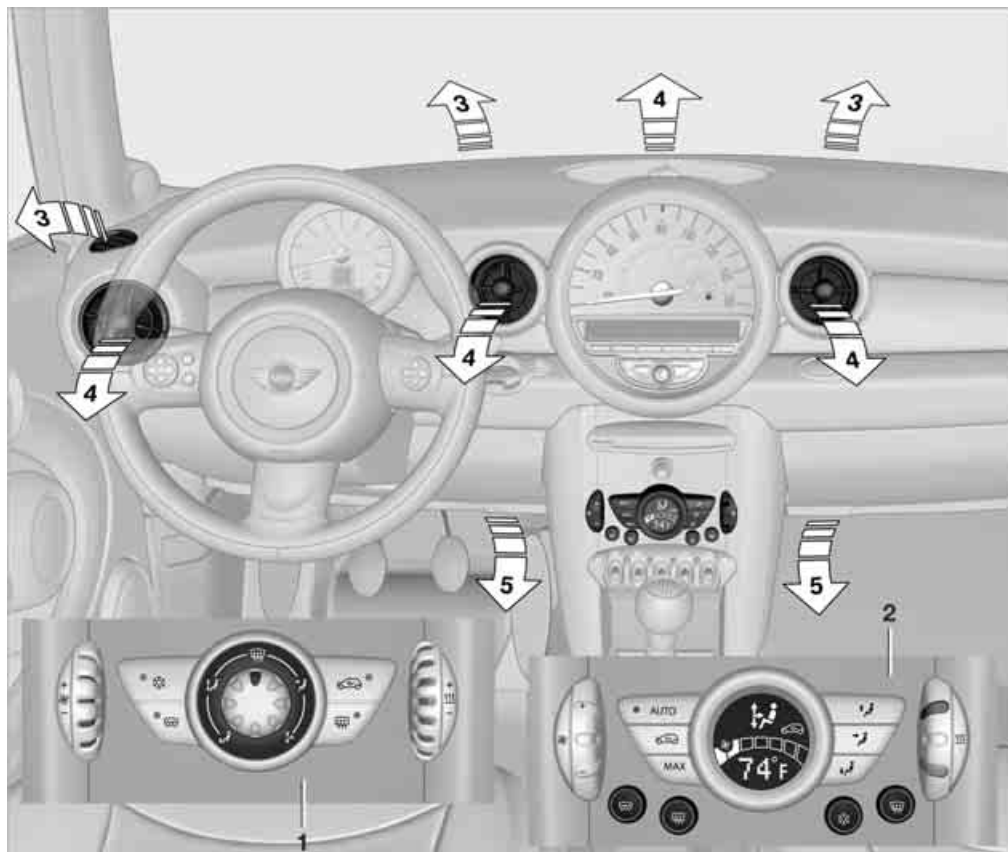

AT A GLANCE

CONTROLS

DRIVING TIPS

MOBILITY

REFERENCE

Equipment versions

Depending on your vehicle's equipment, your MINI contains an air conditioner or an automatic climate control*.

- 1 Air conditioner
- 2 Automatic climate control*

Air vents

- 3 Airflow directed toward the windshield and side windows
- 4 Air to the upper body area, draft-free ventilation
- 5 Air to the footwell

AIR CONDITIONER

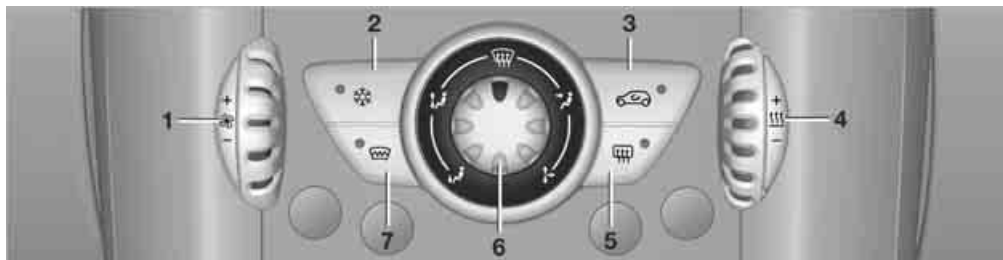

- | | |
|--|---|
| <p>1 Air flow rate</p> <p>2 Cooling function</p> <p>3 Recirculated-air mode</p> <p>4 Temperature</p> | <p>5 Rear window defroster</p> <p>6 Air distribution</p> <p>7 Windshield heating*</p> |
|--|---|

Air flow rate



Adjust the air flow rate. The higher the rate, the more effective the heating or cooling will be.

The air flow rate is lowered or switched off entirely to save on battery power.

Switching the system on/off

Turn the air flow rate rotary switch to 0. Blower and air conditioner are completely switched off and the air supply is cut off.

Set any desired air flow rate to switch on the air conditioner.

Cooling function



When the cooling function is on, the air is cooled, dried, then reheated according to the temperature setting. The recirculated-air mode may be switched on automatically. This function is only available while the engine is running.

The cooling function helps prevent condensation on the windows or removes it quickly.

Depending on the weather, the windshield may fog over briefly when the engine is started.

Recirculated-air mode



If the air outside the car has an unpleasant odor or contains pollutants, shut off the supply to the interior of the car temporarily. The system then recirculates the air currently within the vehicle.



If condensation starts to form on the inside window surfaces, switch off the recirculated-air mode and, if necessary, switch on the cooling function or increase the air flow rate. ◀



To prevent the air quality inside the vehicle from deteriorating during extended use of the recirculated-air mode, fresh air is added briefly at regular intervals. ◀

Temperature



Turn upward, red, to increase the temperature.

Turn downward, blue, to decrease the temperature.



Rear window defroster



The defroster is switched off automatically after a certain time.

Air distribution



Direct the flow of air to the windows , to the upper body area  or to the footwell . Intermediate settings are possible.

Windshield heating*



The windshield heating is switched off automatically after a short time.

Defrosting windows and removing condensation

1. Set air flow rate to the maximum level.
2. Set air distribution to position . Condensation is removed from the windows more quickly when the cooling function* is also activated.
3. Set to the highest temperature, red.
4. Deactivate recirculated-air mode.
5. Turn on windshield heating if necessary.
6. Turn on rear window defroster if necessary.

Microfilter

The microfilter captures dust and pollen. The microfilter is changed by your MINI dealer during routine maintenance work.

AUTOMATIC CLIMATE CONTROL*



- | | |
|----------------------------|--|
| 1 Air flow rate, manual | 6 Temperature |
| 2 AUTO program | 7 Defrosting windows and removing condensation |
| 3 Recirculated-air mode | 8 Cooling function |
| 4 Maximum cooling | 9 Rear window defroster |
| 5 Air distribution, manual | 10 Windshield heating* |

Comfortable interior climate

AUTO program 2 offers the ideal air distribution and air flow rate for almost all conditions, refer to AUTO program below. All you need to do is select an interior temperature which is comfortable for you.

The following sections inform you in detail about how to adjust the settings.

Most settings are stored for the remote control currently in use, refer also to Personal Profile settings on page 19.

Air flow rate, manual



Press the – button to reduce air flow. Press the + button to increase it.

You can reactivate the automatic mode for the air flow rate with the AUTO button.

The air flow rate is lowered or switched off entirely to save on battery power. The display remains the same.

Switching the system on/off

Reduce the air flow by pressing the – button repeatedly until the system is switched off. All indicators go out.

Press the AUTO button to switch the automatic climate control back on.

AUTO program



The AUTO program adjusts the air distribution to the windshield and side windows, towards the upper body area and into the footwell for you. The air flow rate and your temperature specifications will be adapted to outside influences in accordance with seasonal changes, e.g. sunlight.

The cooling function is automatically switched on along with the AUTO program.

Convertible Program

If the soft top is open, the Convertible Program is activated. During the Convertible Program, the automatic climate control is optimized for driving with the soft top down. Furthermore, with increasing vehicle speed, the airflow is also increased.



If attaching the wind reflector, the performance of the Convertible Program can be significantly improved. ◀

Recirculated-air mode



Recirculated-air mode: the supply of outside air is permanently shut off. The system then recirculates the air currently within the vehicle.



If condensation starts to form on the inside window surfaces, press the AUTO button or switch off the recirculated-air mode

and, if necessary, increase the air flow rate. The recirculated-air mode should not be used over an extended period of time; otherwise, the air quality inside the car will deteriorate continuously. ◀

Maximum cooling



At outside temperatures above 32 °F / 0 °C and when the engine is running, you obtain a maximum cooling effect as soon as possible.

The automatic climate control goes into recirculated-air mode at the lowest temperature. Air flows at maximum rate from the vents for the upper body area. You should therefore open them for maximum cooling.

Air distribution, manual



The flow of air is directed to the windows, to the upper body area or to the footwell as selected.

You can switch the automatic air distribution back on by pressing the AUTO button.

Temperature



Set the desired temperature individually.

The automatic climate control achieves this temperature as quickly as possible regardless of the season, using maximum cooling or heating power if necessary, and then maintains it.



If you switch between different temperature settings in quick succession, the automatic climate control does not have enough time to achieve the set temperature. ◀

Rear window defroster



The defroster is switched off automatically after a certain time. Depending on your vehicle's equipment, the upper wires serve as an antenna and are not part of the rear window defroster.

Defrosting windows and removing condensation



Quickly removes ice and condensation from the windshield and front side windows.

For this purpose, also switch on the cooling function. The windshield heating* is switched on automatically.

Windshield heating*



The windshield heating is switched off automatically after a certain time.

Cooling function

The passenger compartment can only be cooled while the engine is running.



When the cooling function is on, the air is cooled, dried, then reheated according to the temperature setting.

The cooling function helps prevent condensation on the windows or removes it quickly.

Depending on the weather, the windshield may fog over briefly when the engine is started. The recirculated-air mode may be switched on automatically.

When the AUTO button is pressed, the cooling function switches on automatically.

Microfilter/activated-charcoal filter

The microfilter captures dust and pollen. The activated-charcoal filter provides additional protection by filtering gaseous pollutants from the outside air. Your MINI dealer replaces this combined filter as a standard part of your scheduled maintenance.

You can call up further information in the service requirements display, page 58.

VENTILATION

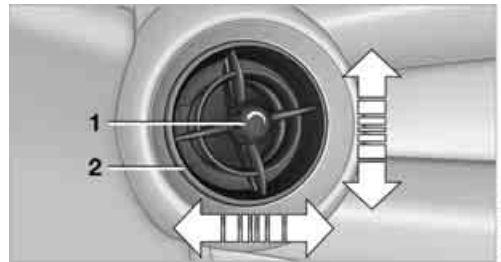

- 1 Knob for continuous opening and closing
- 2 Jet for direction of air flow

Opening/closing

Turn the knob.

Direction of air flow

Swivel the entire jet.

PRACTICAL INTERIOR ACCESSORIES

INTEGRATED UNIVERSAL REMOTE CONTROL*

The concept

The integrated universal remote control can replace as many as three hand-held transmitters for various remote-controlled devices, such as garage and gate openers and lighting systems. The integrated universal remote control registers and stores signals from the original hand-held transmitters.

The signal of an original hand-held transmitter can be programmed on one of the three memory buttons 1. The system in question can then be operated by means of the programmed memory button 1. The LED 2 flashes to confirm transmission of the signal.

If you decide to sell your vehicle one day, in the interest of your own security, remember to clear the stored programs before the vehicle leaves your possession, page 85.

 To prevent possible damage or injury, before programming or using the integrated universal remote control, always inspect the immediate area to make certain that no people, animals or objects are within the pivoting or travel range of the device being operated. Comply also with the safety instructions supplied with the original hand-held transmitter. ◀

Checking compatibility



If this symbol appears on the package or in the instructions supplied with the original hand-held transmitter, you can assume that the radio remote control device is compatible with the integrated universal remote control.

For additional information, please contact your MINI dealer or call: 1-800-355-3515.

You can also obtain information on the Internet at:

www.MINI.com or

www.homelink.com

HomeLink is a registered trademark of Johnson Controls, Inc.

Programming



- 1 Memory buttons
- 2 LED

Fixed-code hand-held transmitters

1. Switch on the ignition, page 44.
2. When starting operation for the first time: Press both outer memory buttons 1 for approx. 20 seconds until the LED 2 flashes rapidly. All stored programs are cleared.
3. Hold the original hand-held transmitter at a distance of approx. 2 in to 12 in/5 to 30 cm from the memory buttons 1.



The required distance between the hand-held transmitter and the memory buttons 1 depends on the system of the respective original hand-held transmitter used. ◀

4. Simultaneously press the transmit key on the original hand-held transmitter and the desired memory button 1 on the integrated universal remote control. The LED 2 flashes slowly at first. As soon as the LED 2 flashes rapidly, release both buttons. If the LED 2 does not flash rapidly after approx. 15 seconds, alter the distance.
5. To program other original hand-held transmitters, repeat steps 3 and 4.

The corresponding memory button **1** is now programmed with the signal of the original hand-held transmitter.

You can operate the system with the engine running or with the ignition switched on.

 If the system fails to function even after repeated programming, check whether the original hand-held transmitter uses an alternating-code system. To do so, either read the instructions for the original hand-held transmitter or hold down the programmed memory button **1** of the integrated universal remote control. If the LED **2** on the integrated universal remote control flashes rapidly and then remains lit for about two seconds, the original hand-held transmitter uses an alternating-code system. If it uses an alternating-code system, program the memory buttons **1** as described under Alternating-code hand-held transmitters. ◀

Alternating-code hand-held transmitters

To program the integrated universal remote control, consult the operating instructions for the device to be set. You will find information there on the possibilities for synchronization or programming of additional hand-held transmitters.

When programming hand-held transmitters that employ an alternating code, please observe the following supplementary instructions:

 Programming will be easier with the aid of a second person. ◀

1. Park your vehicle within the range of the remote-controlled device.
2. Program the integrated universal remote control as described above in the section Fixed-code hand-held transmitters.
3. Locate the button on the receiver of the device to be set, e.g. on the drive unit.
4. Press the button on the receiver of the device to be set. After step 4, you have approx. 30 seconds for the next step 5.
5. Press the programmed memory button **1** of the integrated universal remote control three times.

The corresponding memory button **1** is now programmed with the signal of the original hand-held transmitter.

Clearing stored programs

Press both outer memory buttons **1** for approx. 20 seconds until the LED **2** flashes: all stored programs are cleared.

It is not possible to clear individual programs.

Reassigning individual programs

1. Hold the original hand-held transmitter at a distance of approx. 2 in to 12 in/5 to 30 cm from the memory buttons **1**.

 The required distance between the hand-held transmitter and the memory buttons **1** depends on the system of the respective original hand-held transmitter used. ◀

2. Press the desired memory button **1** of the integrated universal remote control.
3. If the LED **2** flashes slowly after approx. 20 seconds, press the transmit key of the original hand-held transmitter and release both buttons as soon as the LED **2** flashes rapidly.
If the LED **2** does not flash rapidly after approx. 15 seconds, alter the distance and repeat this step.

GLOVE COMPARTMENT

Opening

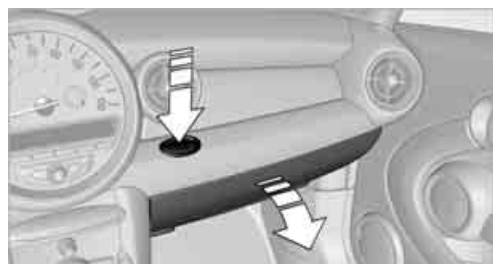

Press the button to open the cover.
The light in the glove compartment comes on.

Closing

Fold cover up.

 To prevent injury in the event of an accident, close the glove compartment after use while the vehicle is being driven. ◀

MINI Convertible: locking

Use the integrated key to lock the remote control system, refer to page 18.

Ventilation*

Depending on your vehicle's equipment, the glove compartment can be ventilated and, if the cooling function* is switched on, can also be cooled.

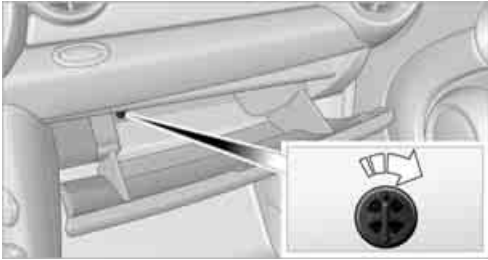

Opening

Rotate the switch in the direction of the arrow.

Closing

Rotate the switch in the opposite direction of the arrow until it is in the vertical position.

Depending on the temperature setting of the air conditioning or the automatic climate control, high temperatures may result in the glove compartment.

CENTER ARMREST*

Storage compartment

The center armrest between the front seats contains either a compartment or the cover for the mobile phone base plate* or the snap-in adapter*.



Opening

The cover slides along guide rails and can be opened fully by pushing it back and lifting it.

Closing

Push the cover forwards.

CONNECTION FOR EXTERNAL AUDIO DEVICE

- ▷ iPods/iPhones or USB devices such as MP3 players and USB memory sticks: connect via the USB audio interface.
- ▷ iPhone/mobile phone music players: connect via the snap-in adapter*, refer to the separate Owner's Manual. Playback is only possible if there is no device connected to the USB audio interface.

Connecting via the USB audio interface

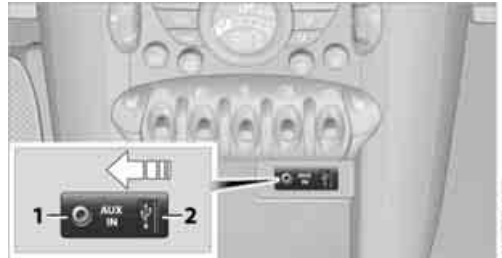

- 1 Connection for audio playback: TRIS connector 1/8"/3.5 mm
- 2 USB interface*

Apple iPod/iPhone

To connect the device, use the special cable adapter for the Apple iPod/iPhone, available from your dealer. The cable adapter is required for a flawless connection.

For additional information, contact your MINI dealer or visit the Internet at www.MINI.com/usb

To play audio tracks over the car's speaker system, connect the iPod to ports **1** and **2**.

The iPod/iPhone's menu structure is supported by the USB audio interface.

USB device

To play audio tracks over the car's speaker system, connect the USB device to port **2**.

Notes

 Do not expose the audio device to extreme environmental conditions, e.g. very high temperatures, refer to the Owner's Manual of the audio device. Otherwise, the audio device may become damaged, which could compromise safety while driving. ◀

- ▷ The USB audio interface supplies the connected audio devices with power, provided that this is supported by the audio device. Therefore, do not connect the USB audio device to the power socket in the vehicle during operation.
- ▷ Do not forcibly connect the plug to the USB interface.
- ▷ Do not connect devices such as fans or lamps to the USB audio interface.
- ▷ Do not connect USB hard disks.
- ▷ Do not use the USB audio interface to charge external devices.

STORAGE COMPARTMENTS

In the vehicle interior

Depending on your vehicle's equipment, you will find storage compartments in the doors, next to the rear seats and in the center console*. The map compartments in the MINI Convertible

are located next to the rear seats.

Nets* are located in the passenger footwell and on the backs of the front seat backrests.

Storage compartment on the front passenger side*

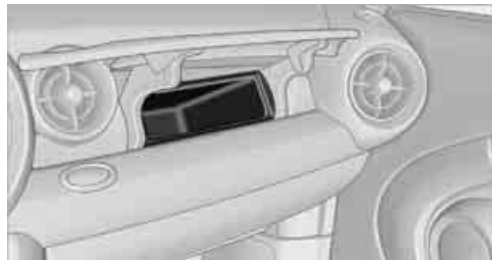

Opening

Briefly press the bottom edge of the cover.

Closing

Push the cover back into its original position.

 To prevent injury in the event of an accident, close the storage compartment after use while the vehicle is being driven. ◀

MINI Convertible

The storage compartment cannot be locked.

Clothes hooks

There are clothes hooks on the grab handles in the rear passenger compartment.

 Items of clothing hung from the hooks must not obstruct the driver's view. Do not hang heavy objects from the hooks; otherwise, they could endanger the car's occupants, e.g. in case of heavy braking or sudden swerving. ◀

In the cargo bay

Depending on your vehicle's equipment, you have the following storage options:

- ▷ Hooks* for hanging up items such as shopping or tote bags on the left and right side-walls of the cargo bay
- ▷ Net* on the cargo bay floor and side trim for smaller objects; for attaching to the lashing eyes and the hook* on the cargo bay side-wall

CUPHOLDERS AND ASHTRAY*



Cupholders

Two cupholders are located in the front of the center console; another is in the rear at the back of the center console.

⚠ Do not place glass containers in the cupholders, as this increases the risk of injury in the event of an accident. ◀

Ashtray*

The ashtray is located in one of the cupholders in the center console.

Emptying

Remove the entire ashtray.

Lighter

With the engine running or the ignition switched on, press in the cigarette lighter.

The lighter can be pulled out as soon as it pops back out.

⚠ Hold or touch the hot cigarette lighter by the knob only. Holding or touching it in other areas could result in burns.

When leaving the car, always remove the key so that children cannot operate the cigarette lighter and burn themselves. ◀

CONNECTING ELECTRICAL APPLIANCES

In your MINI, you can use electrical devices such as a flashlight, car vacuum cleaner, etc., up to approx. 200 watts at 12 volts, as long as one of the following sockets is available. Avoid damaging the sockets by attempting to insert plugs of unsuitable shape or size.

Cigarette lighter socket

Remove the lighter* or cover from the socket.

Power socket in cargo bay

MINI



Pull out the cover.

MINI Convertible



Pull out the cover.





AT A GLANCE

CONTROLS

DRIVING TIPS

MOBILITY

REFERENCE

THINGS TO REMEMBER WHEN DRIVING

BREAK-IN PERIOD

Moving parts need breaking-in time to adjust to each other. Please follow the instructions below in order to achieve the optimal service life and economy of operation for your vehicle.

Engine and differential

Always obey all official speed limits.

Up to 1,200 miles/2,000 km

Drive at varying engine and road speeds, but do not exceed the following:

- ▷ Gasoline engine
4,500 rpm or 100 mph/160 km/h

Avoid full-throttle operation and use of the transmission's kickdown mode.

After driving 1,200 miles/2,000 km

Engine and vehicle speeds can be gradually increased.

Tires

Due to technical factors associated with their manufacture, tires do not achieve their full traction potential until after an initial break-in period. Therefore, drive cautiously during the first 200 miles/300 km.

Brake system

Brakes require an initial break-in period of approx. 300 miles/500 km to achieve optimized contact and wear patterns between brake pads and rotors. Drive cautiously during this break-in period.

Clutch

The function of the clutch reaches its optimal level only after a distance driven of approx. 300 miles/500 km. During this break-in period, engage the clutch gently.

Following part replacement

The same break-in procedures should be observed if any of the components mentioned above have to be renewed in the course of the vehicle's operating life.

GENERAL DRIVING NOTES

Close the liftgate

 Drive the vehicle only when the liftgate is closed. Otherwise, exhaust fumes could penetrate the interior of the vehicle. ◀

If special circumstances make it absolutely necessary to drive with the liftgate open:

1. Close all windows and the glass sunroof*.
2. Switch off the recirculated-air mode and significantly increase the air flow rate of the air conditioner or automatic climate control, page 80 or 82.

Hot exhaust system

 In all vehicles, extremely high temperatures are generated in the exhaust system. Do not remove the heat shields installed adjacent to various sections of the exhaust system, and never apply undercoating to them. When driving, standing at idle and while parking, take care to avoid possible contact between the hot exhaust system and any highly flammable materials such as hay, leaves, grass, etc. Such contact could lead to a fire, with the risk of serious personal injuries and property damage. Do not touch hot exhaust tail pipes. Otherwise, there is a risk of burns. ◀

Hydroplaning

 When driving on wet or slushy roads, reduce road speed. If you do not, a wedge of water can form between tires and road surface. This situation, known as hydroplaning, can cause partial or complete loss of tire contact with the road surface, so that the car cannot be steered or braked properly. ◀

The risk of hydroplaning increases with declining tread depth on the tires, refer also to Tread depth on page 113.

Driving through water

 Drive through water on the road only if it is not deeper than 1 ft/30 cm, and then only at walking speed at the most. Otherwise, the vehicle's engine, the electrical systems and the transmission may be damaged. ◀

Parking brake on inclines

 On inclines, do not hold the vehicle with the clutch; use the parking brake. Otherwise, greater clutch wear will result. ◀

For information on driving off using Hill Assist*, refer to page 65.

Braking safely

Your MINI is equipped with ABS. If you are in a situation which requires full braking, it is best to brake using maximum brake pressure. Since the vehicle maintains steering responsiveness, you can still avoid possible obstacles with a minimum of steering effort.

The pulsation of the brake pedal, together with the sound of hydraulic regulation, indicates that ABS is actively taking effect.

Driving in wet conditions

When roads are wet or there is heavy rain, briefly exert gentle pressure on the brake pedal every few miles. Monitor traffic conditions to ensure that this maneuver does not endanger other road users. The heat generated in this process helps dry the pads and rotors to ensure that Then full braking force will be immediately available when it is needed.

Hills

 To prevent overheating and the resulting reduced efficiency of the brake system, drive long or steep downhill gradients in the gear in which the least braking is required. Even light but consistent brake pressure can lead to high temperatures, brake wear and possibly even brake failure. ◀

You can increase the engine's braking effect by shifting down, all the way to first gear if necessary. This strategy helps you avoid placing excessive loads on the brake system. Downshifting in manual mode of the automatic transmission, page 47.

 Never drive with the clutch held down, with the transmission in neutral or with the engine switched off; otherwise, engine braking action will not be present or there will be no power assistance to the brakes or steering. Never allow floor mats, carpets or any other objects to protrude into the area around the pedals; otherwise, pedal function could be impaired. ◀

Corrosion on brake rotors

When the vehicle is driven only occasionally, during extended periods when the vehicle is not used at all, and in operating conditions where brake applications are less frequent, there is an increased tendency for corrosion to form on rotors, while contaminants accumulate on the brake pads. This occurs because the minimum pressure which must be exerted by the pads during brake applications to clean the rotors is not reached.

Should corrosion form on the brake rotors, the brakes will tend to respond with a pulsating effect that even extended application will fail to cure.

When the vehicle is parked

Condensation forms while the automatic climate control is in operation, and then exits under the vehicle. Traces of condensed water under the vehicle are therefore normal.

In the MINI Cooper S, the coolant pump may continue to run for some time after the engine is switched off. This will generate noise in the engine compartment.

CARGO LOADING

! To avoid loading the tires beyond their approved carrying capacity, never overload the vehicle. Overloading can lead to overheating and increases the rate at which damage develops inside the tires. The ultimate result can assume the form of a sudden blowout. ◀

! Avoid fluid spills in the cargo bay as they could damage the vehicle. ◀

MINI: cargo bay

Cargo bay cover

! Do not place any objects on the cover; otherwise, they could endanger the car's occupants, e.g. in the case of braking or sudden swerving, or they may damage the cover. ◀

When you open the liftgate, the cargo bay cover is raised.

To load bulky luggage, the cover can be removed.

1. Unhook the lift straps from the liftgate.
2. Pull the cover out of the holders toward the rear.

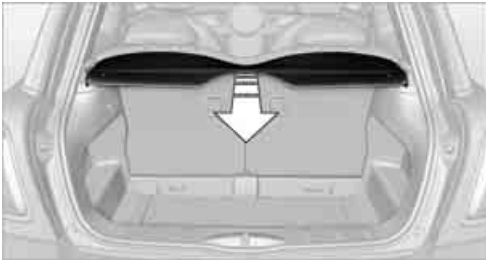

Expanding the cargo bay

The rear set backrest is split. Both sides can be folded separately to expand the cargo bay.

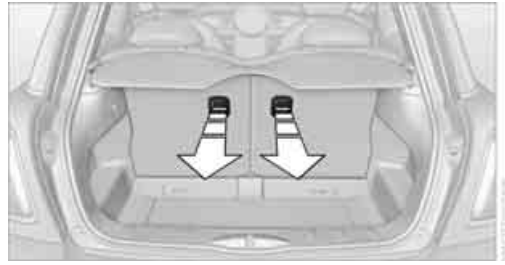

1. Pull the lever.
2. Fold rear seat backrests forward.

! When folding the backrest back up, make sure that the seat's locking mechanisms engage properly. Otherwise, cargo could be thrown around in the event of sharp braking or swerving and endanger the occupants. ◀

Adjusting rear seat backrest*

Expand the cargo bay by raising the split rear seat backrests to a steeper angle.

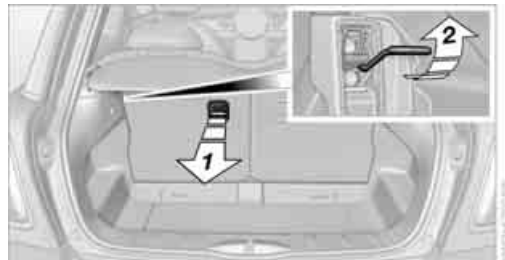

1. Pull the lever, arrow 1, and fold the rear seat backrest forward.
2. Fold up the lever of the backrest lock until it audibly engages, arrow 2.
3. Fold back the backrest until it engages.

! If the rear seat backrests are positioned at a steeper angle, do not install child-restraint systems in the rear of the vehicle as their protective features may be ineffective. ◀

MINI Convertible: luggage compartment

! Do not place any objects on the luggage compartment roller cover, as this may damage the cover or the convertible top. ◀

Loading aid

When the convertible top is closed, you can load the vehicle more easily by releasing the convertible top and folding it up.

1. Release the convertible top using the handles, see arrows 1.

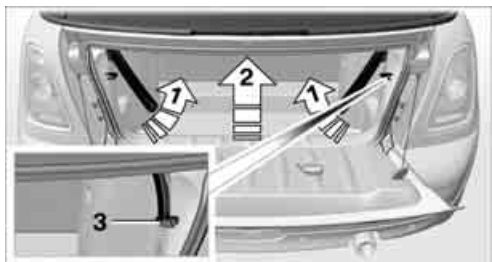

2. Lift the convertible top, see arrow 2.
3. Fold back the handles and place them on holders 3.

Expanding the luggage compartment volume

You can enlarge the luggage compartment volume when the convertible top is closed.

1. Fold the convertible top upwards, refer to Loading aid.



2. Pull luggage compartment roller cover rearward out of the lower brackets and pivot upward, see arrows 1,
3. Push cover into the upper storage areas, see arrows 2 and place down horizontally.

 To operate the convertible top, move the cargo bay cover back to its lower position. ◀

Through-loading system

To be able to transport larger objects, the rear backrest can be folded down.

1. If necessary, use the integrated key and open the backrest lock 1.
2. Press button 2 and fold down backrest together with the belt strap.

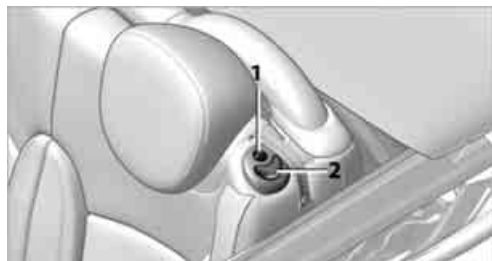

3. Fold the backrest forward.

 When folding the backrest back into its original position, always ensure that the catch engages securely. A loose backrest might fail to prevent cargo from entering the passenger compartment during sudden braking or evasive maneuvers, posing a potential hazard to occupants.

The belt guide loop, refer to page 38, must be closed. ◀

Determining cargo limit



1. Locate the following statement on your vehicle's placard*:

 The combined weight of occupants and cargo should never exceed XXX kg or YYY lbs. Otherwise, the vehicle may be damaged and unstable driving conditions may result. ◀

2. Determine the combined weight of the driver and passengers that will be riding in your vehicle.
3. Subtract the combined weight of the driver and passengers from XXX kilograms or YYY pounds.
4. The resulting figure equals the available amount of cargo and luggage load capacity. For example, if the XXX amount equals 1,400 lbs and there will be four 150 lbs passengers in your vehicle, the amount of available cargo and luggage load capacity is 650 lbs:
1,400 lbs minus 750 lbs = 650 lbs.
5. Determine the combined weight of luggage and cargo being loaded on the vehicle. That weight may not safely exceed the available cargo and luggage load capacity calculated in step 4.
6. If your vehicle will be towing a trailer, part of the load from your trailer will be transferred to your vehicle. Consult the manual for transporting a trailer to determine how this may reduce the available cargo and luggage load capacity of your vehicle.

Load

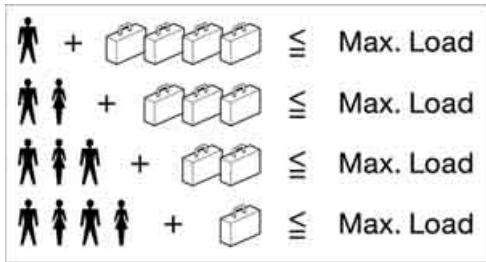

The permissible load is the sum of the occupants' weights and the weight of the cargo. The greater the weight of the occupants, the less cargo/luggage can be transported.

Stowing cargo

- ▷ Position heavy objects as low and as far forward as possible, ideally directly behind the rear seat backrests.
- ▷ Cover sharp edges and corners.

- ▷ For very heavy cargo when the rear seat is not occupied, secure each safety belt in the respective opposite buckle.
- ▷ Do not stack higher than the top edge of the backrests.

MINI

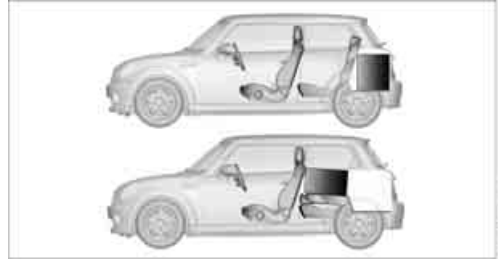

MINI Convertible

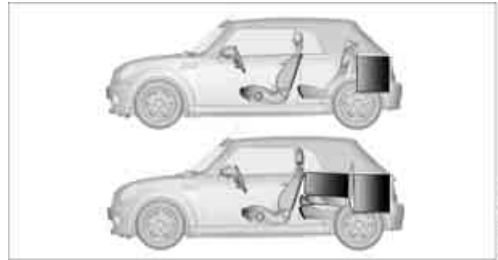

Securing cargo



- ▷ Secure smaller and lighter items using retaining or draw straps*.
- ▷ Heavy-duty cargo straps* for securing larger and heavier objects are available at your MINI dealer. Four lashing eyes are provided for attaching the cargo straps. Two of them are located on the forward wall of the cargo bay.
Comply with the information enclosed with the load-securing devices.

 Always position and secure the cargo as described above, so that it cannot endanger the car's occupants, for example if sudden braking or swerves are necessary.

Do not exceed the approved gross weight and axle loads, page 157; otherwise, the vehicle's operating safety is no longer assured and the vehicle will not be in compliance with the certification regulations.

Heavy or hard objects should not be carried loose inside the car, since they could be thrown around, for example as a result of heavy braking, sudden swerves, etc., and endanger the occupants. Do not secure cargo using the fastening points for the tether strap, page 42; they may become damaged. ◀

MINI: ROOF-MOUNTED LUGGAGE RACK*

A special rack system is available as an option for your MINI. Your MINI dealer will be glad to advise you. Comply with the installation instructions supplied with the rack system.

Mounting points

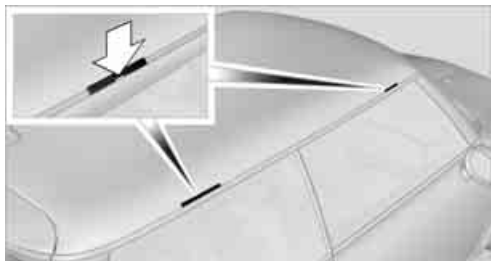

Remove the cover panel.

Loading roof-mounted luggage rack

Because roof racks raise the vehicle's center of gravity when loaded, they have a major effect on vehicle handling and steering response. You should therefore always remember not to exceed the approved roof load capacity, the approved gross vehicle weight or the axle loads when loading the rack.

You can find the applicable data under Weights on page 157.

The roof load must be distributed uniformly and should not be too large in area. Heavy items should always be placed at the bottom.

When loading, make sure that there is sufficient space for the movement of the glass sunroof and that no objects protrude into the swiveling area of the liftgate; otherwise, damage can occur.

Fasten roof-mounted cargo correctly and securely to prevent it from shifting or falling off during the trip.

Drive smoothly. Avoid sudden acceleration and braking maneuvers, and take corners gently.

REAR LUGGAGE RACK*

A specially designed rear luggage rack is available for your MINI Convertible as optional accessory. Please read the information provided in the assembly instructions.

Mounting points

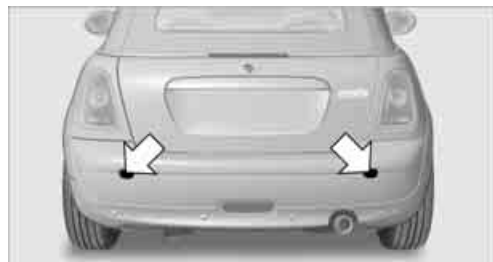

The mounting points can be found under the covers inside the bumper. Push out the covers from the respective recesses.

Loading the rear luggage rack

When loading the rack, please ensure not to exceed the permissible roof load, the permissible gross vehicle weight, and the axle weight.

You can find the applicable data under Weights on page 157.

SAVING FUEL

Fuel consumption depends on a number of different factors. The implementation of certain measures, your driving style and regular maintenance can have an influence on fuel consumption and on the environmental impact.

Remove unnecessary cargo

Additional weight increases fuel consumption.

Remove attached parts no longer in use

Remove auxiliary mirrors, roof- or rear-mounted luggage racks whenever you are not using them.

Attached parts on the vehicle affect its aerodynamics and increase fuel consumption.

Check tire inflation pressure regularly

Check and, if necessary, correct tire inflation pressure at least twice a month and before starting on a long trip.

Low inflation pressure increases rolling resistance and thus leads to greater fuel consumption and tire wear.

Drive off immediately

Do not wait for the engine to warm up while the vehicle remains stationary. Start driving right away, but at moderate engine speeds. This is the fastest way for the cold engine to reach its operating temperature.

Think ahead while driving

Avoid unnecessary acceleration and braking by maintaining a suitable distance to the vehicle driving ahead.

Driving smoothly and anticipating impending traffic situations reduces fuel consumption.

Avoid high engine speeds

Use first gear only for driving off. In second and higher gears, accelerate smoothly to a suitable engine and road speed. In doing so, avoid high engine speeds and shift up early.

When you reach your desired traveling speed, shift to the highest suitable gear and drive at constant speed.

As a rule: driving at low engine speeds lowers fuel consumption and reduces wear.

Coasting

When approaching a red traffic light, take your foot off the accelerator and let the vehicle coast to a halt in the highest suitable gear.

On a downhill gradient, take your foot off the accelerator and let the vehicle coast in a suitable gear.

Fuel supply is shut off automatically when the vehicle is coasting.

Switch off the engine during lengthy stops

Switch off the engine when stopping for lengthy periods, e.g. at traffic lights, railroad crossings or in traffic jams.

Have the vehicle serviced

Have your vehicle serviced regularly to achieve good economy and a long vehicle life. The manufacturer of your MINI recommends having the vehicle serviced by a MINI dealer. Also note the MINI Maintenance System, page 119.





AT A GLANCE

CONTROLS

DRIVING TIPS

MOBILITY

REFERENCE

REFUELING

⚠ Switch off the engine before refueling; otherwise, fuel cannot be added to the tank and a message will be displayed. ◀

⚠ Take all precautionary measures and observe all applicable regulations when handling fuel. Do not carry any spare fuel containers in your vehicle. They can develop a leak and cause an explosion or cause a fire in the event of an accident. ◀

FUEL FILLER FLAP

Opening

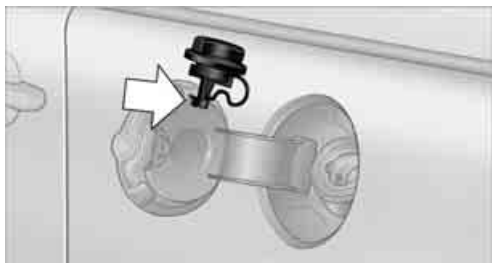

1. Open the fuel filler flap.
2. Turn the gas cap counterclockwise.
3. Place the gas cap in the bracket attached to the fuel filler flap.

Closing

Fit the cap and turn it clockwise until you clearly hear a click.

⚠ Do not pinch the band attached to the cap; otherwise, the cap cannot be closed properly and fuel vapors can escape. A message will be displayed if the gas cap is loose or missing. ◀

Manually releasing the fuel filler flap

In the event of an electrical malfunction, you can manually unlock the fuel filler flap:

1. Remove the cover from the left-hand sidewall of the cargo bay.

MINI:

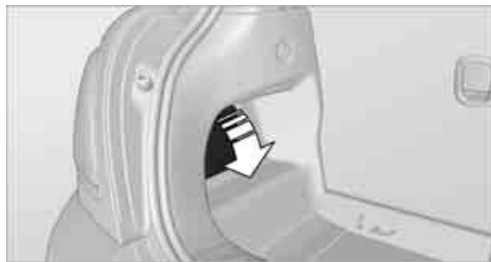

MINI Convertible:

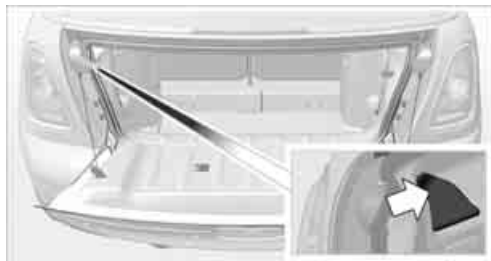

2. Pull on the green knob with the fuel pump symbol. The fuel filler flap is released.

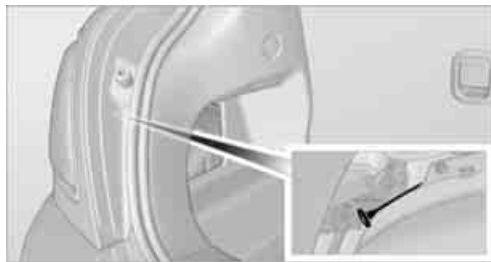

By way of example, the illustration shows the sidewall of the cargo compartment in the MINI.

Observe the following when refueling

 Take all precautionary measures and observe all applicable regulations when handling fuel; otherwise, there is a danger of personal injury and property damage. ◀

When refueling, insert the filler nozzle completely into the filler pipe. Avoid lifting the filler nozzle while filling the tank, as that would lead to

- ▷ premature pump shutoff
- ▷ reduced efficiency of the fuel-vapor recovery system.

The fuel tank is full when the filler nozzle clicks off the first time.

Fuel tank capacity

 If the range displayed is less than 30 miles/50 km, be sure to refuel; otherwise, engine functions are not guaranteed and damage could occur. ◀

Approx. 13.2 US gallons/50 liters, including the reserve capacity of 2.1 US gallons/8 liters.

FUEL SPECIFICATIONS

 Do not use leaded gasoline; otherwise, permanent damage to the catalytic converter will result.

Do not fill the tank with E85, i.e. fuel containing 85 % ethanol, nor with FlexFuel. Otherwise, the engine and fuel supply system will be damaged. ◀

Required fuel

Super Premium gasoline/AKI 91

This gasoline is highly recommended.

However, you may also use gasoline with less AKI. The minimum AKI Rating is:

- ▷ Cooper S, John Cooper Works: 89
- ▷ Cooper: 87

If you use gasoline with this minimum AKI Rating, the engine may produce knocking sounds when starting at high outside temperatures. This has no effect on the engine life.

 Do not use any gasoline below the specified minimum fuel grade. Otherwise, the engine could be damaged. ◀

Use high-quality brands

Field experience has indicated significant differences in fuel quality: volatility, composition, additives, etc., among gasolines offered for sale in the United States and Canada. Fuels containing up to and including 10% ethanol or other oxygenates with up to 2.8% oxygen by weight, that is, 15% MTBE or 3% methanol plus an equivalent amount of co-solvent, will not void the applicable warranties with respect to defects in materials or workmanship.

 The use of poor-quality fuels may result in drivability, starting and stalling problems especially under certain environmental conditions such as high ambient temperature and high altitude.

Should you encounter drivability problems which you suspect could be related to the fuel you are using, we recommend that you respond by switching to a recognized high-quality brand such as gasoline that is advertised as Top Tier Detergent Gasoline.

Failure to comply with these recommendations may also result in unscheduled maintenance. ◀

WHEELS AND TIRES

TIRE INFLATION PRESSURES

Information for your safety

It is not merely the tires' service life, but also driving comfort and, to a great extent, driving safety that depend on the condition of the tires and the maintenance of the specified tire pressure.

Checking pressure

 Check the tire inflation pressure regularly and correct it, if necessary: at least twice a month and before starting long trips. If you fail to observe this precaution you may be driving on tires with incorrect tire pressures, a condition that can not only compromise your vehicle's driving stability, but also lead to tire damage and the risk of an accident. Do not drive with deflated, i.e. flat tires, except when using run-flat tires. A flat tire will seriously impair your vehicle's handling and braking response. Attempts to drive on a flat tire can lead to loss of control over the vehicle. ◀

Check the tire inflation pressures only on cold tires. This means after a maximum of 1.25 miles/ 2 km driving or when the vehicle has been parked for at least 2 hours. When tires are warm, the tire inflation pressure is higher.

 After adjusting the tire inflation pressure, reinitialize the flat tire monitor, page 66, or reset the Tire Pressure Monitor, page 68. ◀

Checking the tire inflation pressure of the space-saver spare tire*

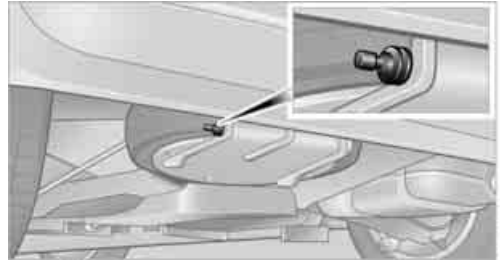

A valve extension for checking the inflation pressure is located behind the bumper.

Inflation pressure specifications

The tables below provide all the correct inflation pressures for the specified tire sizes at ambient temperature.

 The tire inflation pressures apply to the tire sizes approved and the tire brands recommended by the manufacturer of your MINI. Your MINI dealer will be glad to advise you. ◀

For correct identification of the right tire inflation pressures, observe the following:

- ▷ Tire sizes for your vehicle
- ▷ Load conditions
- ▷ Maximum allowable driving speed

Tire inflation pressures for driving up to 100 mph or 160 km/h

For normal driving up to 100 mph or 160 km/h and to achieve optimum driving comfort, adjust pressures to the respective tire inflation pressures listed on the following pages in the columns for traveling speeds up to a maximum of 100 mph or 160 km/h.

These tire inflation pressures can also be found on the driver's side door post when the driver's door is open.



 The maximum permitted speed for these tire inflation pressures is 100 mph or 160 km/h. Do not exceed this speed; otherwise, tire damage and accidents may occur. ◀

Tire inflation pressures for driving above 100 mph or 160 km/h

 In order to drive at maximum speeds in excess of 100 mph or 160 km/h, adjust pressures to the respective tire inflation pressures listed on the following pages in the columns for traveling speeds including those exceeding 100 mph or 160 km/h. Otherwise, tire damage and accidents could occur. ◀

Observe all national and local maximum speed limits; otherwise, violations of the law could occur.

MINI Cooper tire inflation pressures

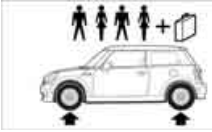
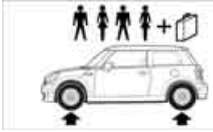
Tire size	Pressure specifications in psi/kPa			
	Speeds up to a max. of 100 mph/160 km/h		Speeds including those exceeding 100 mph/160 km/h	
All pressure specifications in the table are indicated in psi/kilopascal with cold tires. Cold = ambient temperature				
175/65 R 15 84 T M+S				
175/65 R 15 84 H M+S				
175/65 R 15 84 H				
175/60 R 16 82 H M+S RSC				
195/55 R 16 87 H RSC				
195/55 R 16 87 H M+S RSC	33/230	33/230	38/260	38/260
195/55 R 16 87 V M+S RSC				
205/45 R 17 84 V M+S RSC				
205/45 R 17 84 V RSC				
205/45 R 17 84 V M+S RSC				
205/40 R 18 82 W RSC				
Emergency wheel: 115/70 R 15 90 M	60/420	60/420	60/420	60/420
More details on the permissible load and weights can be found on page 157.				

MINI Cooper S tire inflation pressures

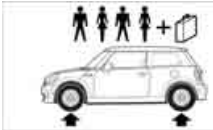
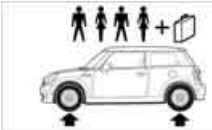
Tire size	Pressure specifications in psi/kPa			
	Speeds up to a max. of 100 mph/160 km/h		Speeds including those exceeding 100 mph/160 km/h	
All pressure specifications in the table are indicated in psi/kilopascal with cold tires. Cold = ambient temperature				
	195/55 R 16 87 V RSC	33/230	33/230	38/260
195/55 R 16 87 H M+S RSC				
195/55 R 16 87 V M+S RSC				
205/45 R 17 84 V M+S RSC				
205/45 R 17 84 V RSC	38/260	38/260	41/280	41/280
205/40 R 18 82 W RSC				
175/60 R 16 82 H M+S RSC				
More details on the permissible load and weights can be found on page 157.				

AT A GLANCE

CONTROLS

DRIVING TIPS

MOBILITY

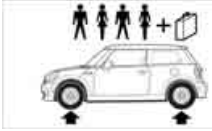
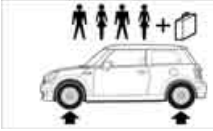

REFERENCE

MINI John Cooper Works tire inflation pressures

Tire size	Pressure specifications in psi/kPa			
	Speeds up to a max. of 100 mph/160 km/h		Speeds including those exceeding 100 mph/160 km/h	
All pressure specifications in the table are indicated in psi/kilopascal with cold tires. Cold = ambient temperature				
185/50 R 17 86 H M+S XL RSC				
205/45 R 17 84 V M+S RSC	38/260	38/260	41/280	41/280
205/45 R 17 84 W RSC				
205/40 R 18 82 W RSC	41/280	41/280	44/300	44/300

More details on the permissible load and weights can be found on page [157](#).

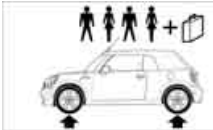
MINI Cooper Convertible tire inflation pressures



Tire size	Pressure specifications in psi/kPa			
	Speeds up to a max. of 100 mph/160 km/h		Speeds including those exceeding 100 mph/160 km/h	
All pressure specifications in the table are indicated in psi/kilopascal with cold tires. Cold = ambient temperature				
175/65 R 15 84 T M+S				
175/65 R 15 84 H				
175/65 R 15 84 H M+S				
175/60 R 16 82 H M+S RSC				
195/55 R 16 87 H RSC	35/240	35/240	38/260	38/260
195/55 R 16 87 H M+S RSC				
195/55 R 16 87 V M+S RSC				
205/45 R 17 84 V RSC				
205/45 R 17 84 V M+S RSC				
205/40 R 18 82 W RSC				
Emergency wheel: 115/70 R 15 90 M	60/420	60/420	60/420	60/420

More details on the permissible load and weights can be found on page 157.

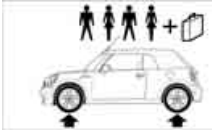
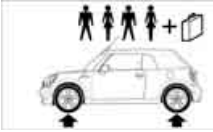
MINI Cooper S Convertible tire inflation pressures

Tire size	Pressure specifications in psi/kPa			
	Speeds up to a max. of 100 mph/160 km/h		Speeds including those exceeding 100 mph/160 km/h	
All pressure specifications in the table are indicated in psi/kilopascal with cold tires. Cold = ambient temperature				
	195/55 R 16 87 V RSC			
195/55 R 16 87 H M+S RSC	35/240	35/240	38/260	38/260
195/55 R 16 87 V M+S RSC				
205/45 R 17 84 V M+S RSC				
205/45 R 17 84 V RSC	39/270	39/270	42/290	42/290
205/40 R 18 82 W RSC				
175/60 R 16 82 H M+S RSC				
More details on the permissible load and weights can be found on page 157 .				

MINI John Cooper Works Convertible tire inflation pressures

Tire size	Pressure specifications in psi/kPa			
	Speeds up to a max. of 100 mph/160 km/h		Speeds including those exceeding 100 mph/160 km/h	
All pressure specifications in the table are indicated in psi/kilopascal with cold tires. Cold = ambient temperature				
	185/50 R 17 86 H M+S XL RSC			
205/45 R 17 84 V M+S RSC	39/270	39/270	42/290	42/290
205/45 R 17 84 W RSC				
205/40 R 18 82 W RSC	42/290	42/290	45/310	45/310
More details on the permissible load and weights can be found on page 158 .				

AT A GLANCE

CONTROLS

DRIVING TIPS

MOBILITY

REFERENCE

TIRE CODING

Knowledge of the labeling on the side of the tire makes it easier to identify and choose the right tires.

Tire size

e.g. 225/45 R 17 91 V

Nominal width in mm

Aspect ratio in %

Radial belt construction

Rim diameter in inches

Load rating, not on ZR tires

Speed code letter, in front of the R on ZR tires

Speed code letter

Q = up to 100 mph or 160 km/h

T = up to 118 mph or 190 km/h

H = up to 131 mph or 210 km/h

V = up to 150 mph or 240 km/h

W = up to 167 mph or 270 km/h

Y = up to 186 mph or 300 km/h

Tire Identification Number

Tires with DOT codes meet the guidelines of the US Department of Transportation.

DOT code:

For instance: DOT xxxx xxx 0810

Manufacturer's code for tire make

Tire size and tire design

Tire age

Uniform Tire Quality Grading

Quality grades can be found where applicable on the tire sidewall between tread shoulder and maximum section width. For example:

Tread wear 200 Traction AA Temperature A

DOT Quality Grades

Tread wear
Traction AA A B C
Temperature A B C



All passenger car tires must conform to Federal Safety Requirements in addition to these grades. ◀

Tread wear

The tread wear grade is a comparative rating based on the wear rate of the tire when tested under controlled conditions on a specified government test course. For example, a tire graded 150 would wear one and one-half (1 ½) times as well on the government course as a tire graded 100. The relative performance of tires depends upon the actual conditions of their use, however, and may depart significantly from the norm due to variations in driving habits, service practices and differences in road characteristics and climate.

Traction

The traction grades, from highest to lowest, are AA, A, B, and C. Those grades represent the tire's ability to stop on wet pavement as measured under controlled conditions on specified government test surfaces of asphalt and concrete. A tire marked C may have poor traction performance.



The traction grade assigned to this tire is based on straight-ahead braking traction tests, and does not include acceleration, cornering, hydroplaning, or peak traction characteristics. ◀

Temperature

The temperature grades are A, the highest, B, and C, representing the tire's resistance to the generation of heat and its ability to dissipate heat when tested under controlled conditions on a specified indoor laboratory test wheel. Sustained high temperature can cause the material of the tire to degenerate and reduce tire life, and excessive temperature can lead to sudden tire failure. The grade C corresponds to a level of performance which all passenger car tires must

meet under the Federal Motor Vehicle Safety Standard No. 109. Grades B and A represent levels of performance on the laboratory test wheel that exceed the minimum required by law.

 The temperature grade for this tire is established for a tire that is properly inflated and not overloaded. Excessive speed, underinflation, or excessive loading, either separately or in combination, can cause heat buildup and possible tire failure. ◀

RSC - run-flat tires*

You will recognize run-flat tires by a circular symbol containing the letters RSC on the side of the tire, page 114.

M+S

Winter and all-season tires. These have better winter properties than summer tires.

XL

Designation for specially reinforced tires.

TIRE CONDITION

Inspect your tires regularly for tread wear, signs of damage and for foreign objects lodged in the tread. Check the tread depth.

Tread depth

The tread depth should not drop below 1/8 in/ 3 mm, although, for example, European legislation only specifies a minimum tread depth of 1/16 in/1.6 mm. At tread depths below 1/8 in/ 3 mm there is an increased risk of high-speed hydroplaning, even when only small amounts of water are present on the road surface.

Winter tires

When winter tires wear down past a tread depth of 1/6 in/4 mm, they become perceptibly less suitable for winter conditions. In the interest of safety, new tires should be installed.

Minimum tread depth

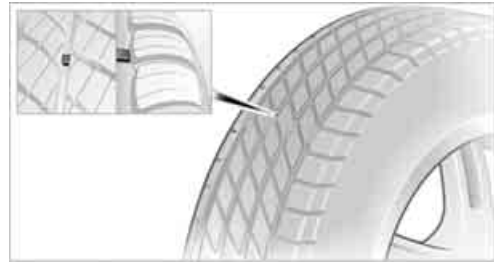

Wear indicators in the base of the tread groove are distributed around the tire's circumference; the letters TWI, for Tread Wear Indicator, on the tire's sidewalls identify tires that incorporate these wear indicators. When tire tread is worn down to the level of the wear indicators, the remaining tread depth is 1/16 in/1.6 mm.

Tire damage

Due to low-profile tires, please note that wheels, tires and suspensions parts are more susceptible to road hazards and consequential damages.

Unusual vibrations encountered during normal vehicle operation can indicate tire failure or some other vehicle defect. This can, for example, be caused by driving over curbs. The same applies to any other abnormal road behavior, such as pulling severely to the right or left.

 In these cases, reduce speed immediately and have wheels and tires thoroughly checked. To do so, drive carefully to the nearest MINI dealer or tire shop that works according to MINI repair procedures with correspondingly trained personnel. If necessary, have the vehicle towed there. Otherwise, tire damage can be extremely dangerous for vehicle occupants and other road users. ◀

Tire age

The manufacturing date of tires is contained in the tire coding:
DOT ... 0810 means that the tire was manufactured in week 8 of 2010.

For various reasons, such as the development of brittleness, the manufacturer of your MINI recommends tire replacement after no more than 6 years, regardless of the actual wear of the tires.

RUN-FLAT TIRES*



The symbol identifying run-flat tires is a circle with the letters RSC on the sidewall. Run-flat tires comprise a conditionally self-supporting tire and a special rim. The reinforcement in the sidewalls ensures that the tire can continue to be used subject to certain restrictions, even if depressurized.

For information on continuing to drive with a flat tire, refer to Indication of a flat tire, page 67.

NEW WHEELS AND TIRES

⚠ Have new wheels and tires mounted only by your MINI dealer or a specialized tire shop that has specially trained personnel working in accordance with the specifications of the MINI manufacturer. If this work is not carried out properly, there is a danger of subsequent damage and related safety hazards. Make sure that the new wheels are balanced. ◀

Retreaded tires

⚠ The manufacturer of your MINI recommends that you avoid using retreaded tires, as this could impair driving safety. The causes for this include potentially different tire casing structures and often wide variations in tire age, which can result in a limited service life. ◀

Correct wheels and tires

⚠ The manufacturer of your MINI recommends mounting only wheels and tires that it has specifically approved for use on your particular model. Although other wheels and tires may theoretically have the same dimensions, variations in factors such as manufacturing tolerances can result in contact between tire and bodywork, ultimately leading to serious accidents. The manufacturer of your MINI cannot evaluate non-approved wheels and tires to determine if they are suited for use, and therefore cannot ensure the operating safety of the vehicle if they are mounted. ◀

Your MINI dealer will be glad to inform you about the correct wheel and tire combination for your vehicle.

The correct combination of wheels and tires is also necessary to ensure reliable operation of various vehicle systems such as ABS and DSC.

To maintain good handling and vehicle response, use only tires of a single brand and tread configuration. After a tire has been damaged, mount the previous wheel and tire combination again as soon as possible.

Wheels with Tire Pressure Monitor TPM electronics

When mounting new tires or changing over from summer to winter tires, or vice versa, only use wheels with TPM electronics; otherwise, the Tire Pressure Monitor may not be able to detect a puncture, refer to page 69. Your MINI dealer will be glad to advise you.

Recommended tire brands

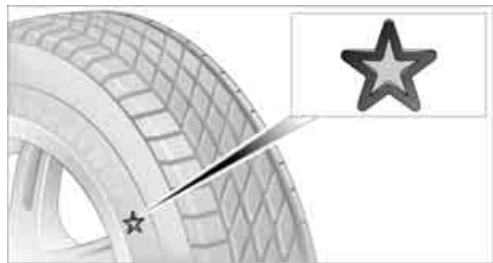

For each tire size, the manufacturer of your MINI recommends certain tire brands. They are marked with a clearly visible MINI designation on the sidewall of the tire.

When properly used, these tires meet the highest standards in terms of safety and handling characteristics.

Run-flat tires*

When mounting new tires or changing over from summer to winter tires and vice versa, mount run-flat tires for your own safety. Keep in mind that no space-saver spare tire is available in the event of a flat. Your MINI dealer will be glad to advise you.

Special characteristics of winter tires

The manufacturer of MINI recommends the use of winter tires on snowy roads or if temperatures drop below 45°F / +7 °C. Although all-season M+S tires provide better winter traction than summer tires, they generally fail to provide the same levels of cold-weather performance as winter tires.

Pay attention to speed

 Always comply with the speed limit for the winter tires mounted on your car; failure to do so could result in tire damage and accidents. ◀

If the car is capable of speeds higher than that permitted for the winter tires, a label stating the maximum permitted speed for the mounted tires must be displayed in your field of view. Specialist tire dealers and your MINI dealer can supply these labels.

Storage

Always store wheels and tires in a cool, dry place with as little exposure to light as possible.

Always protect tires against all contact with oil, grease and fuels.

Do not exceed the maximum tire inflation pressure indicated on the sidewall of the tire.

Swapping wheels among the axles

Depending on the individual use, front and rear tires may exhibit different wear and tear.

In order to maintain an even wear and tear, the wheels may be rotated between the axles. Your MINI dealer will be glad to advise you.

Always check the inflation pressure after the tire rotation, if necessary change the pressure.

SNOW CHAINS*

Only certain types of fine-link snow chains have been tested by the manufacturer of your MINI, classified as road-safe and recommended. Contact your MINI dealer for more details.

Only attach snow chains in pairs to the front wheels with the following tires.

▷ 175/65 R 15 M+S

▷ 175/60 R 16 M+S

John Cooper Works:

▷ 185/50 R 17 86 H M+S XL RSC

Observe the manufacturer's instructions when mounting snow chains. Do not exceed a speed of 30 mph or 50 km/h.

 Do not initialize the Flat Tire Monitor if snow chains are mounted; otherwise, the instrument might issue an incorrect reading. When driving with snow chains, it can be useful to briefly deactivate the DSC or activate the DTC, refer to page 65. ◀

UNDER THE HOOD

⚠ Do not work on the car unless you possess the necessary technical knowledge. If you are not familiar with the regulations to be observed, have the necessary work on your vehicle carried out only by a MINI dealer or a workshop that has specially trained personnel working in accordance with the specifications of the MINI manufacturer. If this work is not carried out properly, there is a danger of subsequent damage and related safety hazards. ◀

HOOD

Releasing



Pull the lever.

⚠ Do not clean the windshield and headlamps if the hood is unlocked as this may damage the headlamp washer system*. ◀

Opening



⚠ To avoid damage, make sure that the wiper arms are against the windshield before you open the hood. ◀

Press the release handle and open the hood.

Closing

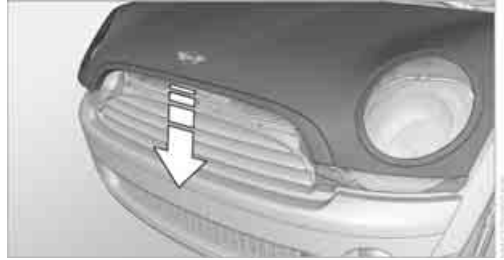

Close the hood from a height of approx. 16 in/ 40 cm with momentum. It must be clearly heard to engage.

⚠ If you notice any signs while driving your vehicle that the hood is not completely closed, stop at once and close it securely. Make sure that the closing path of the hood is clear; otherwise, injuries may result. ◀

IMPORTANT PARTS OF THE ENGINE COMPARTMENT

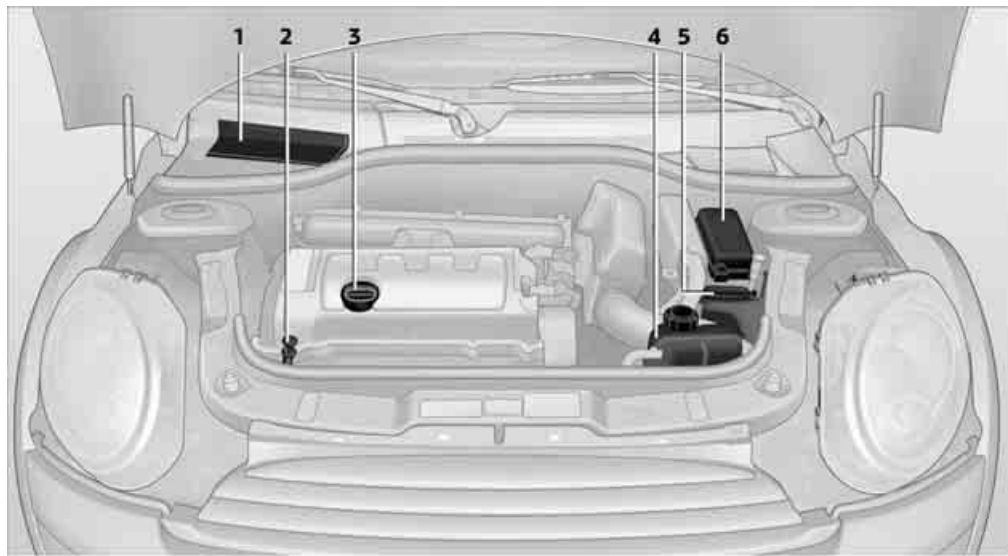

- 1 Battery, under the cover [137](#)
- 2 Engine oil dipstick [117](#)
- 3 Engine oil filler neck [118](#)
- 4 Coolant expansion tank [118](#)
- 5 Reservoir for washer fluid for the headlamp and window washer system [51](#)
- 6 Engine compartment fuse box [135](#)

ENGINE OIL

The engine oil consumption is dependent on driving style and driving conditions.

Check the engine oil level regularly, e.g. when refueling.

Checking engine oil level

1. With the vehicle's engine at normal operating temperature, i.e. after uninterrupted driving for at least 6 miles/10 km, park the vehicle on a level surface.
2. Switch off the engine.
3. Pull the dipstick out after approx. 5 minutes and wipe it off with a lint-free cloth, paper towel or similar material.
4. Carefully push the dipstick all the way into the guide tube and pull it out again.

The oil level should be between the two marks on the dipstick.



The oil quantity corresponding to the difference between the two marks on the dipstick is 1 US quart/1 liter.

 Do not fill beyond the upper mark on the dipstick. Excess oil will damage the engine. ◀

AT A GLANCE

CONTROLS

DRIVING TIPS

MOBILITY

REFERENCE

Adding engine oil

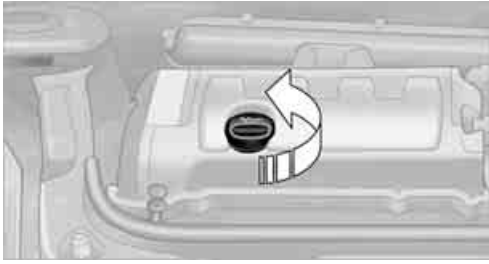

Do not add the maximum quantity of 1 US quart/1 liter of engine oil until the oil level has dropped to just above the lower mark on the dipstick, page 117.

 Add oil within the next 30 miles/50 km; otherwise, the engine could be damaged. ◀

 Keep oils, greases, etc. out of the reach of children and comply with the warnings on the containers. Otherwise, health hazards may result. ◀

Oil change

Have the oil changed only by a MINI dealer or a workshop that has specially trained personnel working in accordance with the specifications of the MINI manufacturer.

Oil types

 Do not use oil additives as this could result in engine damage. ◀

Approved engine oils

Your dealer can advise you on which engine oils have been approved by the manufacturer of your MINI.

The engine oil quality is critical for the life of the engine.

Only use approved High Performance oil.

 The approved oils are SAE 0W-40, 0W-30, 5W-40 and 5W-30. ◀

Alternative oil types

If the approved engine oils are not available, up to 1 US quart/1 liter of another oil with the following specification may be used:

API SM or higher

MINI RECOMMENDS 

COOLANT

 Do not add coolant to the cooling system when the engine is hot. Escaping coolant can cause burns. ◀

Coolant consists of half water and half additive. Not all commercially available additives are suitable for your MINI. Your MINI dealer knows which additives are suitable and will be glad to advise you.

 Only use suitable additives; otherwise, engine damage may result. Because additives are harmful to your health, it is important to follow the instructions on the containers. ◀

 Comply with the appropriate environmental protection regulations when disposing of coolant additives. ◀

Checking coolant level

1. Do not open the hood until the engine has cooled down.
2. Turn the cap of the expansion tank a little counterclockwise to allow any accumulated pressure to escape, then continue turning to open.
3. The coolant level is correct if it is between the Min and Max markings.
4. If the coolant is low, slowly add coolant up to the specified level; do not overfill.
5. Turn the cap until there is an audible click.
6. Have the reason for the coolant loss eliminated as soon as possible.

MAINTENANCE

MINI MAINTENANCE SYSTEM



The MINI Maintenance System supports the preservation of the traffic and operating safety of your MINI. The objective is to optimize efforts with respect to minimal vehicle maintenance costs.

If and when you come to sell your MINI, a comprehensive record of servicing will prove a significant benefit.

Condition Based Service CBS

Sensors and special algorithms take the different driving conditions of your MINI into account. Condition Based Service uses this to determine the current and future service requirements. By letting you define a service and maintenance regimen that reflects your own individual requirements, the system builds the basis for trouble-free driving.

In the tachometer, you can have the remaining times or distances for selected maintenance tasks and any legally prescribed dates displayed, page 58.

Service data in the remote control

Your vehicle continuously stores service-requirement information in the remote control while you are driving. Your MINI dealer can read out this data from the remote control unit, and propose an optimized maintenance approach. Whenever you take your car in for servicing you should therefore hand your MINI dealer the remote control unit that you last used.

 Make sure that the date in the tachometer is always set correctly, page 61; otherwise, the effectiveness of Condition Based Service CBS is not assured. ◀

Service and Warranty Information Booklet for US models and Warranty and Service Guide Booklet for Canadian models

Please consult your Service and Warranty Information Booklet for US models and Warranty and Service Guide Booklet for Canadian models for additional information on service requirements.

 The manufacturer of the MINI recommends that you have service and repair operations performed at your MINI dealer. Take the time to ensure that these service procedures are confirmed by entries in your vehicle's Service and Warranty Information Booklet for US models and Warranty and Service Guide Booklet for Canadian models. These entries verify that your vehicle has received the specified regular maintenance. ◀

SOCKET FOR ONBOARD DIAGNOSIS OBD



The primary components that make up the emissions can be checked by a device via the OBD socket.

EMISSIONS



The warning lamps come on. The vehicle is producing higher emissions. You can continue your journey, but moderate your speed and exercise due caution.

Have the car checked as soon as possible.

Under certain circumstances, one of the lamps will flash or light up continuously. This indicates excessive misfiring or a malfunction in the engine. If this happens, reduce your speed and visit the nearest MINI dealer as soon as possible. Severe misfiring can quickly lead to serious damage of emissions-related components, especially the catalytic converter. In addition, mechanical engine components can become damaged.



If the fuel filler cap is not properly tightened, the OBD system may conclude that fuel vapors are escaping, causing an indicator to light up. If the filler cap is then tightened, the indicator should go out within a few days.

Data memory

Your vehicle displays data about the operation, malfunctions, and user settings. These data are stored in the vehicle and can be partly stored in the remote control; the data can be read by suitable devices, in particular at your service center. The data read out are used for supporting the service processes and repair or for optimization and development of vehicle functions.

CARE

CAR-CARE PRODUCTS

Regular cleaning and care helps to maintain the value of your MINI.

The manufacturer of your MINI recommends using manufacturer-approved products to clean and care for your vehicle.

MINI Service would be pleased to advise you on cleaning and care products and services for your MINI.

 The ingredients of original MINI Care Products have been tested, and the products have been tested in the laboratory and in practice. They offer optimum care and protection for your vehicle. ◀

 Do not use any cleansers containing alcohol or solvents as these may cause damage. ◀

 Cleaning agents may contain hazardous or health-damaging substances. Follow the warning and hazard instructions on the packaging. For interior cleaning, always open the doors or windows of the vehicle. Do not use any products that are not intended for cleaning the vehicle. ◀

EXTERNAL CARE

Washing your vehicle

 Especially during the winter months the vehicle should be frequently washed. Dirt and road salt can damage the vehicle. ◀

 After washing the vehicle, apply the brakes briefly to dry them; otherwise, water can reduce braking efficiency over the short term and the brake rotors can corrode. ◀

Car washes

Preference should be given to cloth car washes.

 Do not use automatic high-pressure car washes; otherwise, water may drip into the vehicle around the windows. ◀

Before driving into the car wash, check if the system is suitable for your MINI. Observe the following points:

- ▷ Dimensions of the vehicle, page 155
- ▷ If necessary: fold in the outside mirrors, page 39.
- ▷ Maximum permissible tire width

 Avoid car washes with tracks higher than 4 in/10 cm; otherwise, the chassis could be damaged. ◀

Preparations for driving into the car wash:

- ▷ Unscrew the rod antenna.
- ▷ Deactivate the rain sensor* to prevent unintentional wiping.
- ▷ Deactivate the rear window wiper* and protect it from damage. Ask the car wash operator about measures that can be taken to protect the wipers.
- ▷ Remove additional attachments, e.g. spoilers or telephone antennas, if there is a possibility that they could be damaged.

Automatic transmission

Before driving into the car wash, make sure that the vehicle can roll:

1. Place the remote control, even with Comfort Access, in the ignition lock.
2. Move the selector lever to position N.
3. Release the parking brake.
4. Switch off the engine.
5. Insert the remote control in the ignition lock so that the vehicle can roll.

Steam jets/high-pressure washers

 When using steam jets or high-pressure washers, ensure that you maintain sufficient clearance to the vehicle and do not exceed a temperature of 140 °F /60 °C.

If the distance is too close, the pressure too high, or the temperature too high, parts of the vehicle can be damaged, or water can penetrate. Observe the operating instructions for high-pressure washers. ◀

 Do not spray sensors such as Park Distance Control with high-pressure washers for a long time or at a distance of less than 1 ft/30 cm. ◀

Manual washing

Use a great deal of water and, if necessary, car shampoo when washing your car by hand. Clean the vehicle with a sponge or a washing brush applying a slight amount of pressure.

 Before cleaning the windshield, deactivate the rain sensor or turn off the ignition to prevent unintentional wiping. ◀

 Observe local regulations regarding washing vehicles by hand. ◀

Headlamps

Do not wipe dry and do not use abrasive or corrosive cleaning agents. Remove dirt and contamination, such as insects, by soaking with shampoo and then washing with plenty of water.

Do not remove accumulated ice and snow with an ice scraper; use window deicers instead.

Windows

Clean the outside and inside of the windows and mirrors with a window cleaner.

 Do not clean the mirrors with cleaners containing quartz. ◀

Wiper blades

Clean with soapy water and change regularly to prevent the formation of streaks.

 Wax, preservatives and dirt on the windows cause streaks when the windshield wipers are on, and can cause premature wear of the wiper blades and interfere with the rain sensor. ◀

Care of the convertible top

The appearance and service life of the convertible top largely depends on its proper care and operation.

Please follow these instructions:

- ▷ Never attempt to fold and stow the convertible top in the convertible compartment when the top is wet or frozen. Otherwise, water stains, mildew, and chafe marks may occur.
- ▷ If water spots occur on the inside headliner despite precautions, remove them using a microfiber cloth and interior cleaner.
- ▷ If the vehicle is parked in an enclosed area for a longer period of time, make sure that there is sufficient ventilation.
- ▷ Remove any bird droppings immediately, since they have corrosive properties which will corrode the convertible top and damage the rubber seals.

 When attempting to remove stains from the convertible top, do not use spot removers, paint thinners, solvents, gasoline, or similar fluids. These cleaners may damage the rubber seals. The improper care or cleaning methods may cause the convertible top and its seams to leak. ◀

Use special convertible top cleaning agents if attempting to remove heavy stains.

Always read and follow the manufacturer's instructions.

Use an impregnating agent to treat the convertible top once a year.

Paintwork, care

Regular care helps your vehicle retain its value and protects the paint from the long-term effects of aggressive substances.

In some regions, environmental factors can affect the vehicle paintwork and damage it. It is therefore important to adjust the frequency and extent of vehicle care correspondingly.

Immediately remove aggressive materials such as spilled fuel, oil, grease, brake fluid, tree sap or bird droppings to prevent damage to the paintwork.

Removing paintwork damage

 Depending on the severity of the damage, immediately repair stone damage or scratches to prevent rusting. ◀

The manufacturer of the MINI recommends repairing paint damage professionally according to factory specifications with original MINI paints.

Preservation

Preservation is necessary when water no longer beads on the clean paint surface. To preserve the paint, only use preservatives that contain carnauba or synthetic waxes.

Rubber seals

Only treat with water or rubber care products.

 Do not use silicon sprays or other silicon-containing care products on rubber seals; otherwise, noise and damage could occur. ◀

Chrome parts*

Carefully clean vehicle parts such as the radiator grill and door handles with copious quantities of water and, if necessary, a shampoo additive, especially when contaminated with road salt. For additional treatment, use chrome polish.

Light-alloy wheels*

The system produces brake dust that collects on the light alloy wheels. Clean them regularly with acid-free wheel cleaner.

 Do not use aggressive, acid-containing highly alkaline or abrasive cleansers or steam jets above 140 °F /60 °C as they may cause damage. ◀

External sensors

 Keep the outside sensors on the vehicle such as the Park Distance Control clean and ice-free to ensure that they function properly. ◀

INTERNAL CARE

Upholstery/fabrics

Regularly use a vacuum cleaner to remove surface dirt.

In case of serious spots such as liquid stains, use a soft sponge or lint-free microfiber cloth and suitable interior cleaners. Observe the instructions on the packaging.

 Clean upholstery up to the seams. Do not rub forcefully. ◀

 Velcro fasteners on pants or other items of clothing can damage seat covers. Make sure that all Velcro fasteners are closed. ◀

Leather/leather coverings*

 The leather processed by the manufacturer of your MINI is a high-quality natural product. Light variations in the grain is one of the typical properties of natural leather. ◀

Dust and road grit in the pores and folds of the leather have an abrasive effect, leading to increased wear and causing the leather surface to become brittle prematurely. Use a cloth or vacuum cleaner to remove dust on a regular basis.

Especially when the leather has a light color, it should be cleaned regularly since it tends to get heavily soiled.

Treat the leather twice a year using a leather lotion since dirt and grease will gradually attack the leather's protective layer.

Carpets/floor mats*

Floor mats can be removed to be cleaned.

If the floor carpet becomes heavily soiled, clean with a microfiber cloth and water or textile cleaner. When doing so, rub forward and back in the driving direction; otherwise, the carpet may become matted.

Interior plastic parts

These include:

- ▷ Plastic surfaces
- ▷ Lamp glass
- ▷ Display panes
- ▷ Mat parts

Only clean with water and, if necessary, solvent-free plastic cleaners.

 Do not use solvents such as alcohol, lacquer thinner, cold cleaners, fuel, or similar, as these will damage the surfaces. ◀

Decorative strips*

Only clean decorative strips with moist cloths. Wipe dry with a soft cloth.

Safety belts

Dirty belt straps impede the reeling action and thus have a negative impact on safety.

 Do not clean chemically, as this may destroy the webbing. ◀

Displays

To clean displays such as radios or display elements, use a display cleaning cloth or a soft, non-scratching, lint-free cloth.

 Avoid pressing too hard when cleaning the display as this can cause damage. ◀

 Do not use chemical or abrasive household cleaning agents. Keep fluids of any kind away from the device. Surfaces or electrical components may otherwise become corroded or damaged. ◀

CD/DVD drives

 Do not use cleaning CDs as this could damage parts of the drive. ◀

VEHICLE STORAGE

If you are not going to drive your car for more than three months, please ask for advice from your MINI dealer or a workshop that works according to MINI manufacturer specifications.

REPLACING COMPONENTS

ONBOARD VEHICLE TOOL KIT



Your vehicle comes with an onboard vehicle tool kit that varies with the equipment version; it is stored underneath the level load floor.

- ▷ Mobility System with onboard vehicle tool kit and tire change set* 130
- ▷ Tire change set with onboard vehicle tool kit for space-saver spare tire 132

WIPER BLADES

Changing the front wiper blades

1. Fold up the wiper arm.

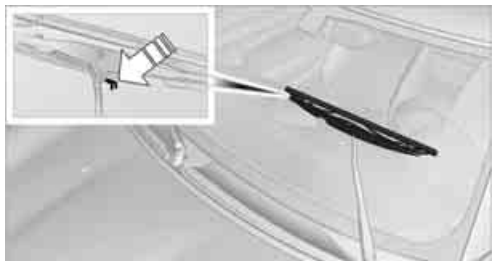

2. Position the wiper blade horizontally.
3. Press the securing spring, arrow.
4. Unhook the wiper blade toward the windshield.
5. Pull the wiper blade past the wiper arm toward the top.
6. Insert the new wiper blade.

7. Press into position until you hear it engage.
8. Fold down the wiper arm.

 To avoid damage, make sure that the wiper arms are against the windshield before you open the hood. ◀

MINI: changing the rear wiper blade



1. Fold up the wiper arm.
2. Rotate the wiper blade toward the back as far as it will go, arrow.
3. Press the wiper blade against the limit and thus out of the mounting.
4. Press the new wiper blade into the fixture until it engages audibly.

LAMPS AND BULBS

Lamps and bulbs make an essential contribution to vehicle safety. They should, therefore, be handled carefully. The manufacturer of your MINI recommends having your MINI dealer perform any work that you do not feel competent to perform yourself or that is not described here.

 Never touch the glass of new bulbs with your bare fingers, as even minute amounts of contamination will burn into the bulb's surface and reduce its service life. Use a clean tissue, cloth or something similar, or hold the bulb by its base. ◀

You can obtain a selection of replacement bulbs at your MINI dealer.

⚠ When working on electrical systems, always begin by switching off the consumer in question; otherwise, short circuits could result. To avoid possible injury or equipment damage when replacing bulbs, observe any instructions provided by the bulb manufacturer. ◀

Caring for headlamps, refer to page 122.

▷ For any bulb replacement not described below, contact a MINI dealer or a workshop that has specially trained personnel working in accordance with the specifications of the MINI manufacturer. ◀

▷ For checking and adjusting headlamp aim, please contact your MINI dealer. ◀

Light-emitting diodes LEDs

Light-emitting diodes installed behind translucent lenses serve as the light sources for many of the controls and displays in your vehicle. These light-emitting diodes are related to conventional laser diodes, and legislation defines them as Class 1 light-emitting diodes.

⚠ Do not remove the covers or expose the eyes directly to the unfiltered light source for several hours; otherwise, this could cause irritation of the retina. ◀

Headlight glass lens

In cool or humid weather, condensation may occur on the interior of outside lights. The condensation disappears a short time after the light is switched on. Headlight glass lenses do not need to be replaced. If a lot of moisture is present, e.g. water droplets in the light, have them checked by your service center.

Xenon lamps*

The service life of these bulbs is very long and the probability of failure very low, provided that they are not switched on and off an excessive number of times. If a xenon lamp fails nevertheless, switch on the fog lamps and continue the journey with great care, provided that local legislation does not prohibit this.

⚠ Have any work on the xenon lamp system, including bulb replacement, carried out only by a MINI dealer or a workshop that has specially trained personnel working in accordance with the specifications of the MINI manufacturer. Due to high voltage, there is a risk of fatal injury if work on the xenon lamps is carried out improperly. ◀

Halogen low beams and high beams

H13 bulb, 60/55 watts

⚠ The H13 bulb is pressurized. Therefore, wear safety glasses and protective gloves. Otherwise, there is a risk of injury if the bulb is damaged. ◀

⚠ Be careful when installing the cover; otherwise, leaks could occur and cause damage to the headlamp system. ◀

Accessing the lamp from the engine compartment

The low-beam/high-beam bulb can be changed from the engine compartment.

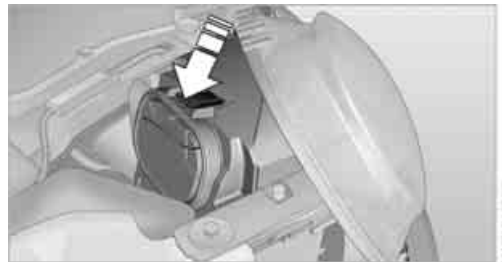

Removing the cover:

1. Press the tab.
2. Flip open the cover and take it out of the holder.

Follow the same steps in reverse order to reattach the cover.

⚠ Be careful when installing the cover; otherwise, leaks could occur and cause damage to the headlamp system. ◀

Replacing the bulb

1. Turn the lamp counterclockwise, arrow 1, and remove it, arrow 2.

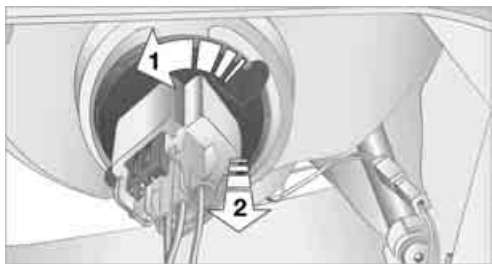

2. Push on the catch, arrow 1, and unplug the connector, arrow 2.

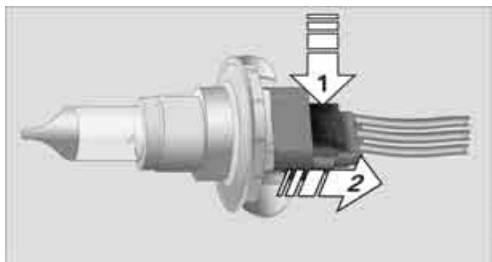

3. To insert the new bulb and replace the cover, proceed in reverse order.

Turn signal indicators, parking lamps, roadside parking lamps and fog lamps

Accessing the lamps via the wheel well



- 1 Turn signal
- 2 Parking/roadside parking/fog lamps

Replacing a turn signal bulb

21 watt bulb, PY 21 W

1. Turn in the wheel.

2. Remove cover 1.
To do so, turn the cover counterclockwise.
3. Remove the inside cover.
To do so, turn the cover counterclockwise.



4. Screw out the bulb counterclockwise.

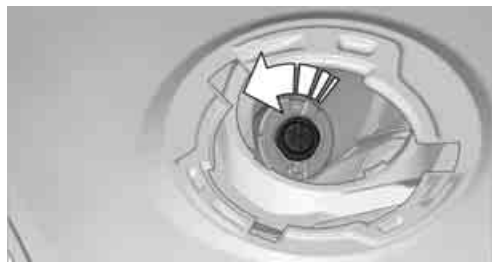

5. To insert the new bulb and replace the covers, proceed in reverse order.

Replacing a parking/roadside parking lamp bulb

5 watt bulb, W 5 W

1. Turn in the wheel.
2. Remove cover 2.
To do so, turn the cover counterclockwise.
3. Screw out the upper bulb counterclockwise.



4. To insert the new bulb and replace the cover, proceed in reverse order.

Replacing a fog lamp bulb

H8 bulb, 35 watts

1. Turn in the wheel.
2. Remove cover **2**.
To do so, turn the cover counterclockwise.
3. Screw out the lower bulb counterclockwise.



4. To insert the new bulb and replace the cover, proceed in reverse order.

Side turn signal indicators

5 watt bulb, W 5 W

1. Push the lamp with the ventilation grate forward and remove.

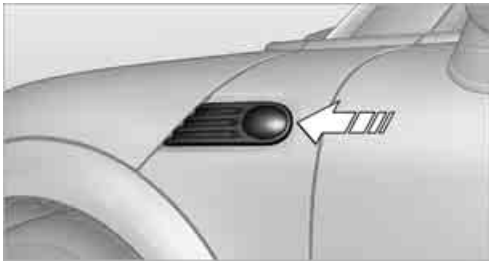

2. Screw out the bulb holder counterclockwise.
3. Pull out and replace the bulb.
4. To insert the new bulb and replace the cover, proceed in reverse order.

Tail lamps

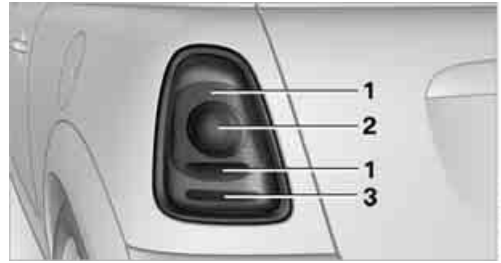

- 1 Brake lamp/tail lamp
21 watt/5 watt bulb, W 5 W
- 2 Turn signal lamp
21 watt bulb, P 21 W
- 3 Backup lamp
21 watt bulb, P 21 W

Lamp access

MINI:

Remove the cover from the sidewall of the cargo bay.

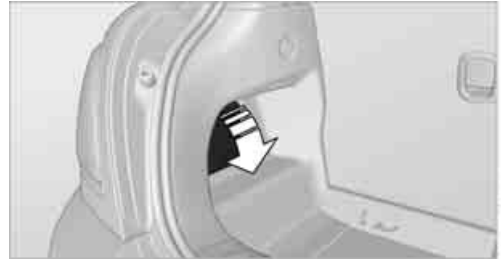

MINI Convertible:

Move the convertible top to its uppermost position, refer to Loading aid page 95, and remove the cover of the luggage compartment side wall.

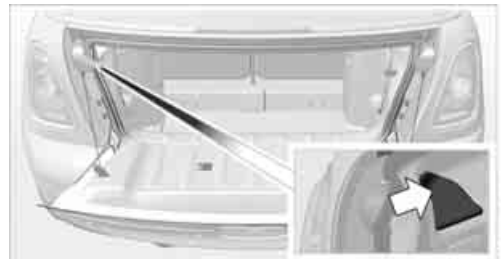

Changing

1. Screw out the desired bulb counterclockwise, arrows 1.
- Additional bulbs are located behind the sidewall of the cargo bay, arrow 2.

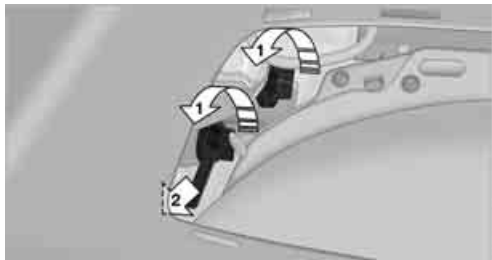

2. To insert the new bulb and replace the cover, proceed in reverse order.

Rear fog lamp*

21 watt bulb, P 21 W

Access to the lamp via the back or underside of the bumper.

The illustration shows the fog lamp in the bumper of the MINI Cooper.

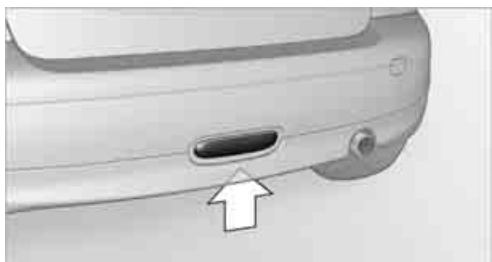

1. Screw out the bulb holder counterclockwise.
2. Screw out and replace the bulb.
3. To insert the new bulb and bulb holder, proceed in reverse order.

License plate lamps

5 watt bulb, C 5 W



1. Using a screwdriver, push the lamp to the left in the tab of the lamp housing, arrow 1.
2. Remove the lamp, arrow 2.
3. Replace the bulb.
4. Insert the lamp.

Center brake lamp

This lamp uses LED technology for operation. In the event of a malfunction, contact your MINI dealer or a workshop that has specially trained personnel working in accordance with the specifications of your MINI manufacturer.

REPAIRING A FLAT TIRE



Safety measures in the event of a breakdown:

Park the vehicle as far as possible from moving traffic and switch on the hazard warning flashers.

Turn the steering wheel until the front wheels are in the straight-ahead position and engage the steering wheel lock. Engage the parking brake and shift into 1st or reverse gear or place the selector lever in position P.

All passengers should be outside the vehicle and in a safe place, e.g. behind a guardrail.

Erect a warning triangle or warning flasher at the appropriate distance if necessary. Comply with all safety guidelines and regulations. ◀

In the event of a flat tire, different procedures should be followed depending on the equipment included in your vehicle:

- ▷ MINI Mobility System, refer to the following section
- ▷ Run-flat tires, page 114
- ▷ Tire change with space-saver spare tire, page 132

MINI Mobility System with onboard vehicle tool kit and tire change set*

Preparations

Use of the MINI Mobility System may be ineffective if the tire puncture measures approx. 1/8 in/ 4 mm or more. Contact the nearest MINI dealer if the tire cannot be made drivable with the Mobility System.

Do not remove foreign bodies which have penetrated the tire if possible.

▷ Follow the instructions on using the Mobility System found on the compressor and the sealant bottle. ◀

Remove the adhesive label for the speed limit from the sealant bottle and affix it to the steering wheel.

The Mobility System with onboard vehicle tool kit and tire change set* is located under the floor mat in the cargo bay.

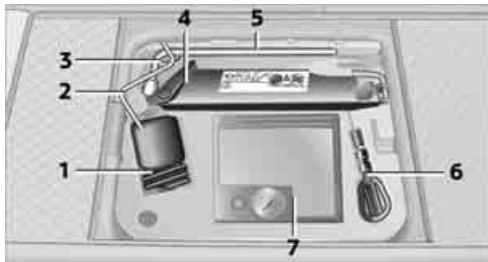

- 1 Sealant bottle
- 2 Hexagon wrench*
- 3 Extractor hook*
- 4 Vehicle jack*
- 5 Wheel stud wrench
- 6 Flat screwdriver/Phillips screwdriver, towing eyelet
- 7 Compressor

Sealant and compressor



- 1 Sealant bottle and adhesive label with speed limit
- 2 Filling hose

▷ Note the use-by date on the sealant bottle. ◀

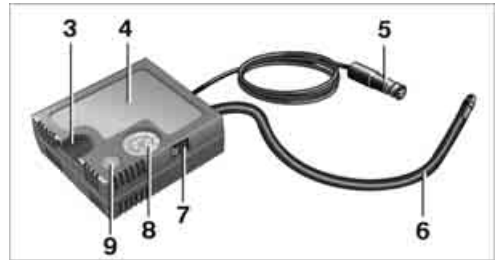

- 3 Holder for the sealant bottle
- 4 Compressor
- 5 Plug and cable for the socket in the vehicle interior, page 88
- 6 Connection hose to connect the compressor and sealant bottle or the compressor and wheel
- 7 On/off switch
- 8 Pressure gauge for indicating the tire inflation pressure
- 9 Release button for reducing the tire inflation pressure

Connector, cable and connection hose are stored in the compressor housing.

Using the Mobility System

To repair a tire puncture with the Mobility System, proceed as follows:

- ▷ Filling the tire with sealant
- ▷ Distribute the sealant
- ▷ Correct the tire inflation pressure

Filling the tire with sealant

⚠ Proceed in the specified order; otherwise, sealant may emerge under high pressure. ◀

1. Shake the sealant bottle.
2. Pull the connection hose **9** out of the compressor housing fully and screw it onto the connector of the sealant bottle. Make sure that the hose is not kinked.
3. Insert the sealant bottle on the compressor housing in an upright position.

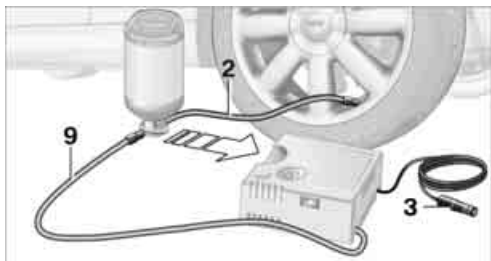

4. Unscrew the dust cap from the valve of the defective wheel and screw the filling hose **2** of the sealant bottle onto the valve.
5. Ensure that the compressor is switched off.
6. Insert the plug **3** into the lighter socket/ power socket in the vehicle interior, page 88.
7. With the engine running: Switch on the compressor and let it run for approx. 3 to 8 minutes to fill the tire with sealant and achieve a tire inflation pressure of approx. 26 psi/180 kPa.

▷ When filling the tire with sealant, the inflation pressure can briefly rise to approx. 73 psi/500 kPa. Do not switch off the compressor during this phase. ◀

⚠ Do not run the compressor for longer than 10 minutes; otherwise, the device will overheat and possibly be damaged. ◀

8. Switch off the compressor.

If an air pressure of 26 psi/180 kPa is not reached:

1. Unscrew the filling hose **2** from the wheel and drive the vehicle forward and backward approx. 33 ft/10 m to distribute the liquid sealant in the tire evenly.
2. Inflate the tire again with the compressor.

▷ If an inflation pressure of 26 psi/180 kPa still cannot be reached, the tire is too heavily damaged. Please contact the nearest MINI dealer. ◀

Stowing Mobility System

1. Unscrew filler hose **2** of the sealant bottle from the wheel.
2. Unscrew connecting hose of the compressor **9** from the sealant bottle.
3. Connect the filler hose **2** of the sealant bottle to the unoccupied connection on the sealant bottle. This prevents the rest of the sealant from escaping from the bottle.
4. Wrap the empty sealant bottle in suitable material to avoid dirtying the cargo bay.
5. Stow Mobility System back in the vehicle.

Distributing the sealant

Immediately drive approx. 3 mls/5 km to evenly distribute the sealant.

▷ Do not exceed speeds of 50 mph/ 80 km/h.

If possible, do not drop below 10 mph/ 20 km/h. ◀

Correcting the tire inflation pressure

1. After driving approx. 3 mls/5 km or ten minutes, stop at a suitable location.
2. Screw the connection hose **2** of the compressor directly onto the tire valve.
3. Insert the plug **3** into the power socket in the vehicle interior.
4. Correct the inflation pressure to 26 psi/ 180 kPa. With the engine running:

- ▷ To increase the inflation pressure: switch on the compressor. To check the current inflation pressure, switch off the compressor.



Do not run the compressor for longer than 10 minutes; otherwise, the device will overheat and possibly be damaged. ◀

- ▷ To decrease the inflation pressure: press the release button 5.



If the tire cannot maintain the inflation pressure, drive the vehicle again, refer to Distributing the sealant. Then repeat steps 1 to 4.

If an inflation pressure of 26 psi/180 kPa still cannot be reached, the tire is too heavily damaged. Contact the nearest MINI dealer. ◀

Driving on



Do not exceed the permitted maximum speed of 50 mph/80 km/h; doing so may result in an accident. ◀

Replace the defective tire as soon as possible and have the new wheel/tire assembly balanced.

Have the Mobility System refilled.

CHANGING WHEELS

Space-saver spare tire*

To change a space-saver spare tire, proceed as follows:

- ▷ Remove the space-saver spare tire, page 132
- ▷ Prepare for tire change, page 133
- ▷ Jack up vehicle, page 134
- ▷ Mount space-saver spare tire, page 134
- ▷ Tighten lug bolts, page 134
- ▷ Drive with space-saver spare tire, page 133

Tire change set for a space-saver spare tire*

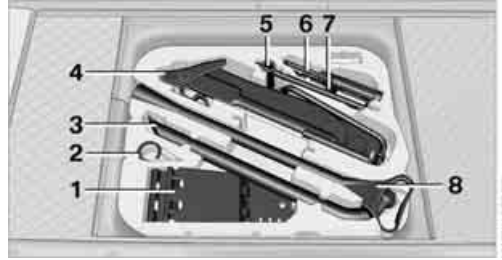

On vehicles with a space-saver spare tire, the tire change set with onboard tools is stored under the floor mat in the cargo bay.

- 1 Chock, folding
- 2 Extractor hook*
- 3 Wheel stud wrench
- 4 Vehicle jack
- 5 Special wrench for removing the space-saver spare tire
- 6 Flat screwdriver/Phillips screwdriver
- 7 Towing eyelet
- 8 Lifting handle

The onboard vehicle tool kit includes a pouch with a plastic bag in which you can place the damaged wheel.

Removing the space-saver spare tire

The screw connection of the space-saver spare tire is under the floor mat in the cargo bay, on the base of the storage compartment for the tire change set.

1. Unscrew the screw connection with the special wrench.
2. Take out the cover panel.



- Screw the lifting handle from the onboard vehicle tool kit onto the thread.

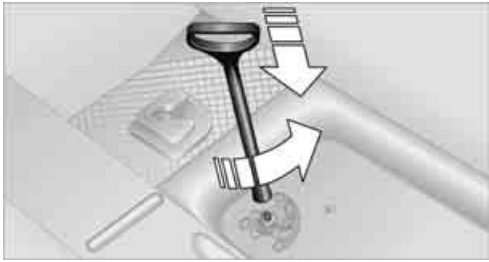

- Raise the lifting handle slightly.
- Squeeze the securing spring.

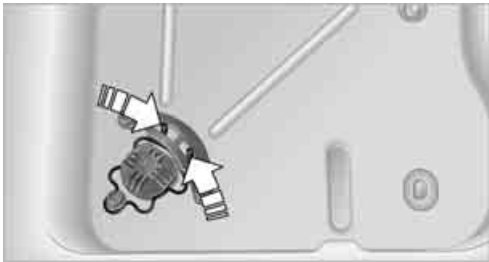

- The space-saver spare tire is released and must be held by the lifting handle.
- Lower the space-saver spare tire with the lifting handle.
- Unscrew the lifting handle.
- Pull the space-saver spare tire underneath the vehicle out towards the rear.



- Position the space-saver spare tire with the valve facing upward.
- Unscrew the valve extension from the valve of the space-saver spare tire.

- Unscrew the dust cap from the extension and place it on the valve of the space-saver spare tire.

▶ Due to its different dimensions, the damaged wheel cannot be placed in the recess for the space-saver spare tire. ◀

Driving with the space-saver spare tire

⚠ Drive cautiously and do not exceed a speed of 50 mph/80 km/h. Changes may occur in vehicle handling such as lower track stability during braking, longer braking distances and changes in self-steering properties when close to the handling limit. These properties are more noticeable with winter tires. ◀

⚠ Only one space-saver spare tire may be mounted at one time. Mount a wheel and tire of the original size as soon as possible, to avoid any safety risks. ◀

▶ Check the tire inflation pressure at the earliest opportunity and correct it if necessary. Replace the defective tire as soon as possible and have the new wheel/tire assembly balanced. ◀

Preparing for a tire change

▶ Observe the safety precautions regarding flat tires on page 129. ◀

⚠ Additional safety measures when changing tires:

Only change the tire when parked on a surface that is level, firm and not slippery.

The vehicle or the jack could slip sideways on soft or slippery support surfaces, such as snow, ice, flagstones, etc.

Do not use a wooden block or similar object as a support base for the jack, as this would prevent it from extending to its full support height and reduce its load-carrying capacity.

Do not lie under the vehicle or start the engine when the vehicle is supported by the jack; otherwise, there is a risk of fatal injury. ◀

1. Place the foldable chock* behind the front wheel on the other side of the vehicle or in front of the wheel if the vehicle is on an incline. If the wheel is changed on a surface with a more severe slope, take additional precautions to secure the vehicle from rolling.
2. Uncover the lug bolts if necessary.
3. Loosen the lug bolts by a half turn.

Jacking up the vehicle

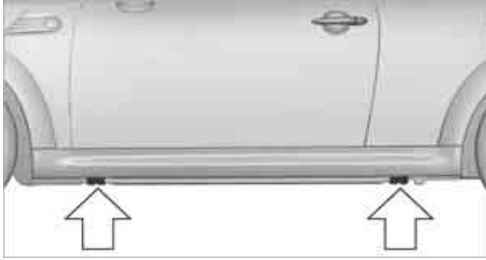

⚠ The vehicle jack is designed for changing wheels only. Do not attempt to raise another vehicle model with it or to raise any load of any kind. To do so could cause accidents and personal injury. ◀

1. Place the jack at the jacking point closest to the wheel.
The jack base must be perpendicular to the surface beneath the jacking point.



2. During jacking up, insert the jack head in the square recess of the jacking point.
3. Jack the vehicle up until the wheel you are changing is raised off the ground.

Mounting the space-saver spare tire

1. Unscrew the lug bolts and remove the wheel.
2. Remove accumulations of mud or dirt from the mounting surfaces of the wheel and hub. Clean the lug bolts.
3. Lift the new wheel into place.
4. Screw at least two lug bolts finger-tight into opposite bolt holes.
5. Screw in the remaining bolts.
6. Tighten all the lug bolts firmly in a diagonal pattern.
7. Lower the vehicle.
8. Remove the jack.

Tightening the lug bolts

Tighten the lug bolts in a diagonal pattern.

⚠ Immediately have the wheels checked with a calibrated torque wrench to ensure that the lug bolts are firmly seated. Otherwise, incorrectly tightened lug bolts can present a safety hazard. ◀

Tightening torque: 103.3 lb ft or 140 Nm.

Replace the defective tire as soon as possible and have the new wheel/tire assembly balanced.

VEHICLE BATTERY

Maintenance

The battery is 100% maintenance-free, the electrolyte will last for the life of the battery when the vehicle is operated in a temperate climate.

Battery replacement

⚠ Only use vehicle batteries that have been approved for your vehicle by the manufacturer; otherwise, the vehicle could be damaged and systems or functions may not be fully available. ◀

After a battery replacement, have the battery registered on the vehicle by your dealer to ensure that all comfort functions are fully available.

Charging the battery

Only charge the battery in the vehicle when the engine is off. Connections, refer to Jump-starting on page 136.

Disposal



After replacing old batteries, return the used batteries to your MINI dealer or to a recycling point. Maintain the battery in an upright position for transport and storage. Always secure the battery against tipping over during transport. ◀

Power failure

After a temporary power loss, some equipment may not be fully functional and may require initialization. Individual settings are also lost and must be reprogrammed:

- ▷ Time and date
These values must be updated, page 60.
- ▷ Radio
Stations must be stored again, refer to the separate Owner's Manual for Radio.
- ▷ Glass sunroof*, electric
It may only be possible to raise the sunroof, if applicable. The system must be initialized. Contact your nearest MINI dealer.

FUSES



Do not attempt to repair a blown fuse or replace it with a fuse of a different color or Ampere rating. To do this could cause a fire in the vehicle resulting from a circuit overload. Have the fuse changed only by a MINI dealer or a workshop that has specially trained personnel working in accordance with the specifications of the MINI manufacturer. ◀

A fuse allocation diagram is located on the inside of the fuse box cover panels.

In the engine compartment



Opening the cover

Press the latch.

In the vehicle interior

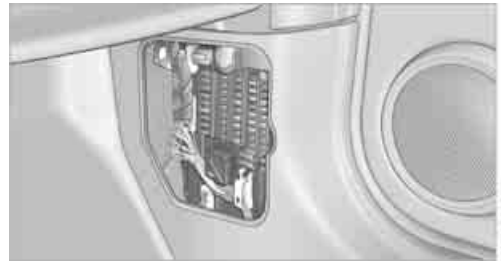

On the right side of the footwell.

Opening the cover

Press out at the recess.

GIVING AND RECEIVING ASSISTANCE

ROADSIDE ASSISTANCE

Roadside Assistance is available by phone 24 hours a day in many countries. You can receive assistance there in the event of an emergency.

Phone numbers for Roadside Assistance are listed in the Contact brochure.

FIRST AID POUCH*

Some of the articles contained in the first aid pouch have a limited service life. Therefore, check the expiration dates of the contents regularly and replace any items in good time, if necessary.



By way of example, the illustration shows the cargo bay in the MINI.

The first aid pouch is located on the cargo bay floor by the left side trim panel.

WARNING TRIANGLE*

MINI

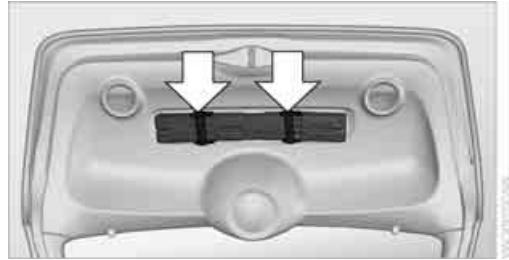

On the inside of the liftgate.

Press the tab to take it out.

MINI Convertible

The warning triangle is located at the bottom of the luggage compartment floor.

JUMP-STARTING

If the car's own battery is flat, your MINI's engine can be started by connecting two jumper cables to another vehicle's battery. You can also use the same method to help start another vehicle. Only use jumper cables with fully-insulated clamp handles.



Do not touch any electrically live parts when the engine is running, or a fatal accident may occur. Carefully adhere to the following sequence, both to prevent damage to one or both vehicles, and to guard against possible personal injuries. ◀

Preparation

1. Check whether the battery of the other vehicle has a voltage of 12 volts and approximately the same capacitance in Ah. This information can be found on the battery.
2. Switch off the engine of the support vehicle.
3. Switch off any consumers in both vehicles.

 There must not be any contact between the bodies of the two vehicles; otherwise, there is a danger of shorting. ◀

Connecting jumper cables

 Connect the jumper cables in the correct order, so that no sparks which could cause injury occur. ◀

1. Open the battery cover in the engine compartment to access the positive terminal of your MINI. ◀

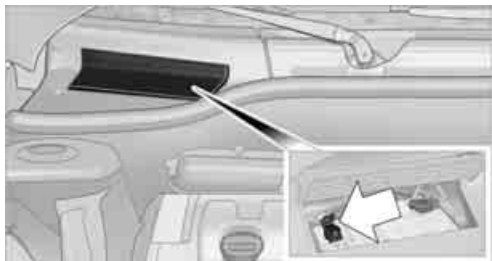

2. Release the tabs of the positive terminal cover* on the left and right, arrows 1, and lift the cover to open, arrow 2. ◀

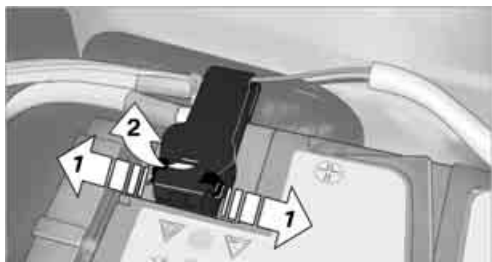

3. Attach one terminal clamp of the plus/+ jumper cable to the positive terminal of the battery or to a starting-aid terminal of the vehicle providing assistance. ◀
4. Attach the second terminal clamp of the plus/+ jumper cable to the positive terminal of the battery or a starting-aid terminal of the vehicle to be started. ◀
5. Attach one terminal clamp of the minus/- jumper cable to the negative terminal of the battery or to an engine or body ground of the assisting vehicle. ◀

Body ground in MINI:

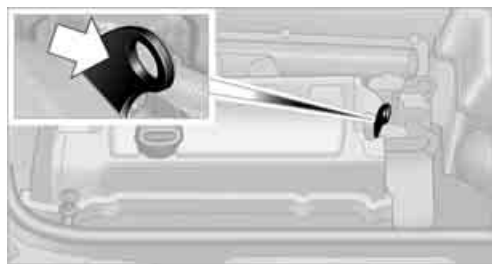

6. Attach the second terminal clamp of the minus/- jumper cable to the negative terminal of the battery or to the engine or body ground of the vehicle to be started. ◀

Starting the engine

1. Start the engine of the donor vehicle and allow it to run for a few minutes at slightly increased idle speed. ◀
2. Start the engine of the other vehicle in the usual manner. ◀
If the first start attempt is not successful, wait a few minutes before another attempt in order to allow the discharged battery to recharge. ◀
3. Let the engines run for a few minutes. ◀
4. Disconnect the jumper cables by reversing the above connecting sequence. ◀

If necessary, have the battery checked and recharged. ◀

 Never use spray fluids to start the engine. ◀

TOW-STARTING, TOWING AWAY

 Observe the applicable laws and regulations for tow-starting and towing vehicles. ◀

 Do not transport any passengers other than the driver in a vehicle that is being towed. ◀

Using a tow fitting

The screw-in tow fitting must always be carried in the car. It can be screwed in at the front or rear of the MINI.

It is stored in the onboard vehicle tool kit in the cargo bay underneath the cover on the right-hand side, page 125.

 Use only the tow fitting provided with the vehicle and screw it all the way in. Use the tow fitting for towing on paved roads only. Avoid lateral loading of the tow fitting, e.g. do not lift the vehicle by the tow fitting. Otherwise, the tow fitting and the vehicle could be damaged. ◀

Access to screw thread

Push out the cover of the towing eye out of the recess in the bumper.

Front

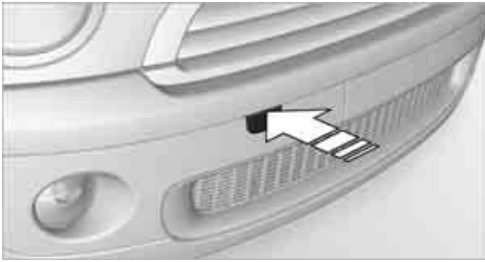

Rear

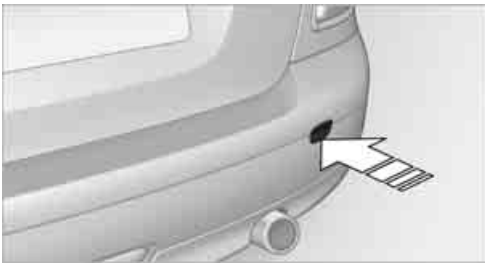

Being towed

 Make sure that the ignition is switched on, refer to page 44; otherwise, the low beams, tail lamps, turn signal indicators and windshield wipers may be unavailable. Do not tow the vehicle with just the rear axle raised, as this would allow the steering to turn. ◀

There is no power assist while the engine is off. Thus, braking and steering will require increased effort.

Switch on the hazard warning flashers, depending on local regulations.

Manual transmission

Gearshift lever in neutral position.

Automatic transmission

 Tow vehicles with automatic transmission only with a tow truck or with the front wheels lifted; otherwise, the transmission can be damaged. ◀

Towing with a tow bar

 The towing vehicle must not be lighter than the towed vehicle; otherwise, it may be impossible to maintain control. ◀

The tow fittings used should be on the same side on both vehicles. Should it prove impossible to avoid mounting the tow bar at an angle, please observe the following:

- ▷ Clearance and maneuvering capability will be sharply limited during cornering.
- ▷ The tow bar will generate lateral forces if it is attached offset.

 Attach the tow bar to the tow fittings only, as attaching it to other parts of the vehicle could result in damage. ◀

Towing with a tow rope

When starting off in the towing vehicle, make sure that the tow rope is taut.

 To avoid jerking and the associated stresses on vehicle components when towing, always use nylon ropes or nylon straps. Attach the tow rope to the tow fittings only, as attaching it to other parts of the vehicle could result in damage. ◀

Towing with a tow truck

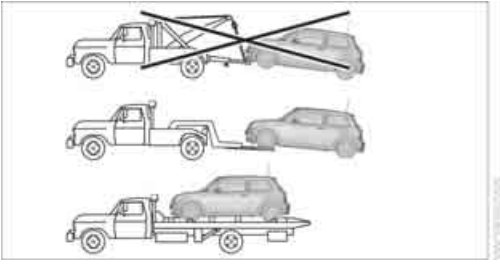

Have the MINI or MINI Convertible transported by a tow truck with a so-called lift sling or on a flatbed.

 Do not lift the vehicle by a tow fitting or body and chassis parts; otherwise, damage may result. ◀

Tow-starting

Avoid tow-starting the vehicle whenever possible; instead, jump-start the engine, page 136. Vehicles with a catalytic converter should only be tow-started when the engine is cold, vehicles with an automatic transmission cannot be tow-started at all.





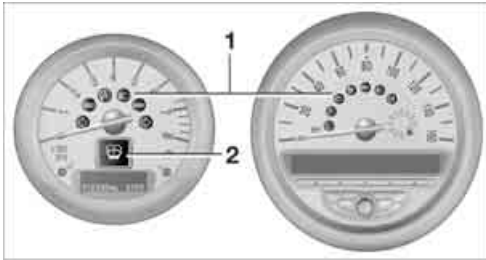





1. Switch on hazard warning flashers, comply with local regulations.
2. Switch on the ignition, page 44.
3. Shift into 3rd gear.
4. Have the vehicle tow-started with the clutch completely depressed and then slowly release the clutch. After the engine starts, immediately depress the clutch completely again.
5. Stop at a suitable location, remove the tow bar or rope and switch off the hazard warning flashers.
6. Have the vehicle checked.





INDICATOR AND WARNING LAMPS













Indicator and warning lamps can light up in various combinations and colors in indicator area 1 or 2. See the table for information on causes and how to react. Note whether a lamp comes on alone or in combination with another. Some lamps can light up in different colors. Corresponding distinctions are made in the text.









1	2	Cause	What to do
		Turn signals	
		High beams/headlamp flasher switched on	
		Fog lamps switched on	
		Rear fog lamp switched on	
		Fasten safety belts	Fasten your safety belt, refer also to page 39.
<small>BRAKE</small> 		Indication in US models Parking brake applied	Release the parking brake.
		Indication in Canadian models Parking brake applied	Release the parking brake.
		Outside temperature warning	Drive cautiously, refer also to page 53.











1	2	Cause	What to do
	<p>Lights up briefly:</p> <p>Approx. 2.1 US gallons/8 l of fuel remain in the tank</p> <hr/> <p>Remains on:</p> <p>Cruising range is no more than 30 miles/50 km, page 54</p>		
	Engine refuses to start	Depress the brake or clutch in order to start the engine, page 44.	
	Ignition switched on and driver's door open	Switch off the ignition, page 44, or close the driver's door.	
	Lamps still on		
	Roadside parking lamps on		
	Door open		
	Hood open		
	Liftgate open		
	Luggage compartment roller cover in the MINI Convertible	Convertible top cannot be activated. Bring cargo bay cover in required position, refer to page 95.	
	<p>Lights up in red:</p> <p>Convertible top not locked</p>	Convertible top cannot be activated. Complete open/close of convertible top before continuing drive, refer to page 31.	











1	2	Cause	What to do
		Sliding/tilting sunroof or soft top of MINI Convertible	Excessive vehicle speed, activation not possible, reduce speed and continue activation .
		Lights up in red: Control system for convertible top failed!	Position of convertible top and locking mechanism not recognized. If convertible top securely locked, drive may be continued. Manually close convertible top/sliding roof, refer to page 32. Have your MINI Service inspect the system.
		Lights up in yellow: Drive of convertible top overheated!	Let drive of convertible top cool down, refer to page 32.
		Sliding/tilting sunroof or soft top of MINI Convertible	Control system of convertible top/tilt roof malfunctioning. Close convertible top/tilt roof manually, refer to page 32. Contact your MINI Service.
		Tailgate of MINI Convertible not closed	Close the tailgate.
		Gas cap missing or loose	Make sure that the gas cap is correctly positioned and close it until it audibly clicks. Do not jam the strap between the gas cap and the vehicle.
		Window washer fluid level too low	Add washer fluid as soon as possible, page 51.
		Lights up in red: Service due	Arrange a service appointment. Check service requirements, page, 119.
		Lights up in yellow: The engine will start the next time the start/stop button is touched, possibly without the brake or clutch being depressed	







1	2	Cause	What to do
		Remote control malfunctioning or, in cars with Comfort Access, not detected	The engine cannot be started. Have the remote control checked, if necessary.
		Remote control battery is discharged	Use the remote control for a longer journey or, in cars with Comfort Access, replace the battery.
		Belt tensioners and/or airbag system failed	Have the system checked immediately. Fasten the safety belts anyway.
		Power steering failed	You can continue your journey, but moderate your speed and exercise due caution. Steering response will be markedly different. Have the system checked without delay.
		Lights up in red: Engine malfunction	Stop the car and switch off the engine. You cannot continue your journey. Contact your MINI dealer.
		Lights up in yellow: Full engine power no longer available	You can continue your journey, but moderate your speed and exercise due caution. Have the engine checked as soon as possible.
		Indicator lamp 1 flashes: Engine malfunction under high load. High engine load will result in damage to the catalytic converter	You can continue your journey, but moderate your speed and exercise due caution. Have the vehicle checked without delay.
		Indicator lamp 1 comes on: Engine malfunction with adverse effect on exhaust emissions	You can continue your journey, but moderate your speed and exercise due caution. Have the car checked as soon as possible.



1	2	Cause	What to do
	<p>Lights up in red:</p> <p>Engine overheating</p>	<p>Carefully bring the car to a stop, switch off the engine and allow it to cool down. Do not open the hood; otherwise, there is a risk of injury from scalding. Contact your MINI dealer.</p>	
	<p>Lights up in yellow:</p> <p>Engine too hot</p>		<p>Continue driving at more moderate speed so that the engine can cool down. Have the engine checked without delay if the situation reoccurs.</p>
	<p>Lights up in red:</p> <p>Battery is no longer being charged. Alternator malfunction</p>	<p>Switch off all unnecessary electrical consumers. Have the battery checked without delay.</p>	
	<p>Lights up in yellow:</p> <p>Battery charge level very low, battery aged or not securely connected</p>		<p>Have the battery checked as soon as possible.</p>
<p>BRAKE</p>	<p>Indication in US models</p> <p>Parking brake applied</p>		
	<p>Indication in Canadian models</p> <p>Parking brake applied</p>		











1	2	Cause	What to do
BRAKE		Indication in US models	
		Lights up in red:	
		Brake fluid level too low	Brake pedal travel may be markedly longer. Stop immediately. Contact the nearest MINI dealer.
		Lights up in yellow:	
		Hill Assist failed. The car will not be held in place after the brake is released	Have the system checked as soon as possible.
		Indication in Canadian models	
		Lights up in red:	
		Brake fluid level too low	Brake pedal travel may be markedly longer. Stop immediately. Contact the nearest MINI dealer.
		Lights up in yellow:	
		Hill Assist failed. The car will not be held in place after the brake is released	Have the system checked as soon as possible.
BRAKE		Indication in US models	
		Brake pads worn	Have the condition of the brake pads checked without delay.
		Indication in Canadian models	
		Brake pads worn	Have the condition of the brake pads checked without delay.
ABS BRAKE		Indication in US models	
		Vehicle electronics failed	You cannot continue your journey. Contact your MINI dealer.
			



1	2	Cause	What to do
  		<p>Indication* in Canadian models</p> <p>Vehicle electronics failed</p>	<p>You cannot continue your journey. Contact your MINI dealer.</p>
<p>ABS</p>  		<p>Indication* in Canadian models</p> <p>Vehicle electronics failed</p>	<p>You cannot continue your journey. Contact your MINI dealer.</p>
	<p>Lights up in red:</p> <ul style="list-style-type: none"> ▷ Starter failed or ▷ ignition malfunctioning. Engine restart only possible when brake is depressed or ▷ lighting system failed. Low beams/tail lamps and brake lamps still operational. All other lamps failed 	<p>Lights up in red:</p> <p>Have the system in question checked without delay.</p> <p>The engine cannot be restarted.</p> <p>Depress the brake to start the engine again.</p>	<p>Have the system in question checked without delay.</p> <p>The engine cannot be restarted.</p> <p>Depress the brake to start the engine again.</p>
	<p>Lights up in yellow:</p> <ul style="list-style-type: none"> ▷ Control of the brake lamps failed or ▷ fuel supply malfunctioning ▷ Drive malfunctioning 	<p>Lights up in yellow:</p> <p>You can continue your journey, but moderate your speed and exercise due caution. Have the system in question checked without delay.</p> <p>You can continue your journey, but moderate your speed and exercise due caution. Transmission limp-home program active with restricted range of gears. Have the system checked immediately.</p>	<p>You can continue your journey, but moderate your speed and exercise due caution. Have the system in question checked without delay.</p> <p>You can continue your journey, but moderate your speed and exercise due caution. Transmission limp-home program active with restricted range of gears. Have the system checked immediately.</p>
	<p>Flashing: Dynamic Stability Control DSC or Dynamic Traction Control DTC is controlling drive and braking forces, refer also to page 63</p>		

1	2	Cause	What to do
DTC	DTC	Dynamic Traction Control DTC is activated, refer also to page 64	
		The Dynamic Stability Control DSC and Dynamic Traction Control DTC are deactivated, refer also to page 63	Driving stability limited during acceleration and cornering. Driving style must be adjusted.
		The Dynamic Stability Control DSC and Dynamic Traction Control DTC have failed.	Driving stability limited during acceleration and cornering. You can continue your journey, but moderate your speed and exercise due caution. Have the system checked as soon as possible.
ABS BRAKE 		Indication in US models The driving stability control systems, including ABS and the Tire Pressure Monitor, have failed, refer also to page 63	Reduced braking and driving stability. Drive cautiously and think well ahead. Avoid braking with full force, driving on rough tracks, and depressing the accelerator pedal to full throttle or kickdown position. Have the system checked immediately.
		Indication* in Canadian models The driving stability control systems, including ABS and the Flat Tire Monitor or the Tire Pressure Monitor*, have failed, refer also to page 63	Reduced braking and driving stability. Drive cautiously and think well ahead. Avoid braking with full force, driving on rough tracks, and depressing the accelerator pedal to full throttle or kickdown position. Have the system checked immediately.
ABS 		Indication* in Canadian models The driving stability control systems, including ABS and the Flat Tire Monitor or the Tire Pressure Monitor*, have failed, refer also to page 63	Drive cautiously and think well ahead. Avoid braking with full force, driving on rough tracks, and depressing the accelerator pedal to full throttle or kickdown position. Have the system checked immediately.

1	2	Cause	What to do
 	Vehicles with Flat Tire Monitor*		
	Light up in yellow and red: <ul style="list-style-type: none"> ▷ Tire damage ▷ Flat Tire Monitor not initialized 		Carefully bring the car to a stop. Observe the information starting on page 66. Initialize Flat Tire Monitor, page 66.
		Light up in yellow:	
		Flat Tire Monitor failed. Punctures are not indicated	Have the system checked.
 	Vehicles with Tire Pressure Monitor*		
	Light up in yellow and red:		
		There is a flat tire or substantial loss in tire pressure	Carefully bring the car to a stop. Observe the information starting on page 68.
 	Vehicles with Tire Pressure Monitor*		
	Light up in yellow:		
		Tire Pressure Monitor not initialized	Check the inflation pressure and reset the system, page 69.
		The small lamp flashes yellow and then stays on, the large lamp lights up in yellow:	
		<ul style="list-style-type: none"> ▷ Tire Pressure Monitor failed. Punctures are not indicated ▷ Wheel mounted without TPM electronics ▷ The TPM is temporarily malfunctioning due to other systems or devices using the same radio frequency. 	Have the system checked. Have the system checked.

1	2	Cause	What to do
		<p>Lights up in red:</p> <ul style="list-style-type: none"> ▷ Transmission limp-home program active with restricted range of gears, possibly with reduced acceleration ▷ Gears can be engaged without depressing the brake ▷ Automatic selector lever locked <hr/> <p>Lights up in yellow:</p> <ul style="list-style-type: none"> ▷ Automatic selector lever locked: Selector lever locked in position P with engine running and brake depressed or ▷ brake signal malfunctioning: gear can be engaged without depressing the brake 	<p>You can continue your journey, but moderate your speed and exercise due caution. Have the system checked without delay.</p> <p>Always depress the brake to engage a gear.</p> <p>Manually unlock the selector lever lock, page 48.</p> <hr/> <p>Have the system checked as soon as possible.</p> <p>Manually unlock the selector lever lock, page 48.</p> <p>To engage a gear while the vehicle is at a standstill, always depress the brake. Before leaving the vehicle, move the selector lever to position P and switch off the engine.</p>
		<p>Lights up in red:</p> <p>Transmission overheating</p> <hr/> <p>Lights up in yellow:</p> <p>Transmission too hot</p>	<p>Bring the car to a stop and move the selector lever to position P. Allow the transmission to cool down. You can continue your journey, but moderate your speed and exercise due caution. Have the system checked if the situation reoccurs.</p> <p>Avoid high engine loads. You can continue your journey, but moderate your speed and exercise due caution.</p>
		<p>Selector lever position P not engaged. Vehicle not prevented from rolling</p>	

1	2	Cause	What to do
	Selector lever position P not engaged. Ignition cannot be switched off	Engage selector lever position P when you wish to switch off the ignition, page 44.	
	Cruise control system failed	Have the system checked.	
	Park Distance Control failed	Have the system checked.	
	Bulb of exterior lighting system failed	Have the exterior lighting checked as soon as possible.	
	Low-beam headlamp or fog lamp failed	Have the lamps checked as soon as possible.	
	High-beam headlamp failed	Have the high-beam headlamps checked.	
	Rear fog lamp failed	Have the rear fog lamp checked.	
	Headlamp beam throw adjustment system failed	Have the headlamp beam throw adjustment system checked.	
	Coolant level too low	Add coolant immediately, page 118.	
	Engine oil pressure too low	Stop immediately and switch off the engine. You cannot continue your journey. Contact your MINI dealer.	
	Lights up in red: Service appointment overdue	Arrange a service appointment. Check service requirements, page 58.	
	Lights up in yellow: Service due	Arrange a service appointment. Check service requirements, page 58.	

1	2	Cause	What to do
		No service due	
		Set speed limit exceeded	
		Time and date no longer correct	Set the time and date, page 60.

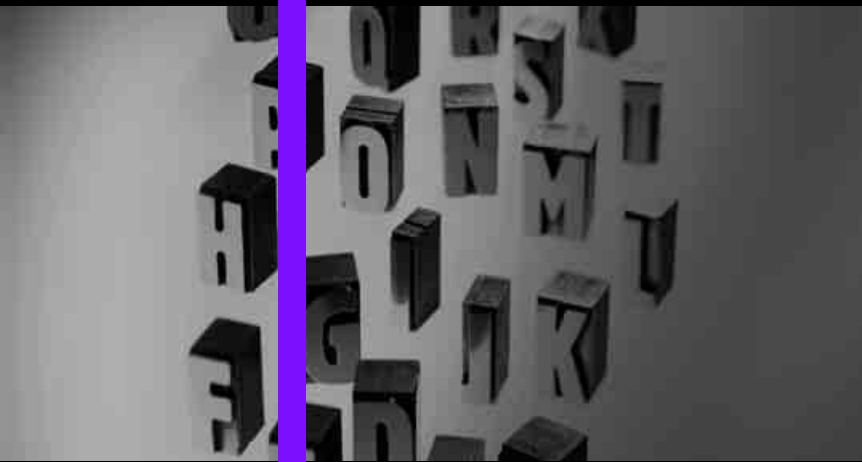

AT A GLANCE

CONTROLS

DRIVING TIPS

MOBILITY

REFERENCE

TECHNICAL DATA

In the technical data, only the values that differ from the Cooper S are shown for the John Cooper Works.

ENGINE DATA

		Cooper	Cooper S	John Cooper Works
Displacement	cu in/ cm ³	97.5/ 1,598	97.5/ 1,598	97.5/ 1,598
Number of cylinders		4	4	4
Maximum power output	hp	118	172	208
At engine speed	rpm	6,000	5,500	6,000
Maximum torque with overboost	lb ft/ Nm	114/155 –	177/240 192/260	192/260 207/280
At engine speed with overboost	rpm	4,250 –	1,600–5,000 1,700–4,500	1,850–5,600 2,000–5,100
Overboost briefly raises the maximum torque at high rates of acceleration, e.g. when passing.				

DIMENSIONS

MINI

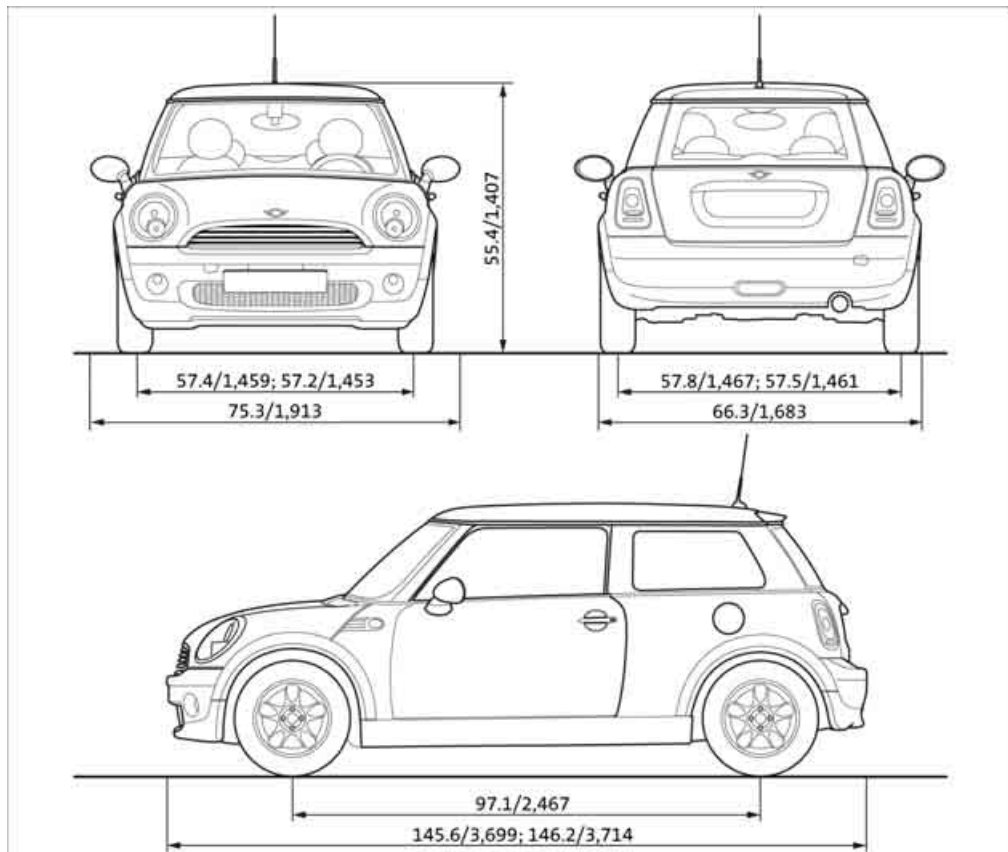

All dimensions in inches/mm. Minimum turning radius Ø: 35 ft 10 in/10.7 m.
Information after the semicolon: different values for MINI Cooper S.

AT A GLANCE

CONTROLS

DRIVING TIPS

MOBILITY

REFERENCE

MINI Convertible

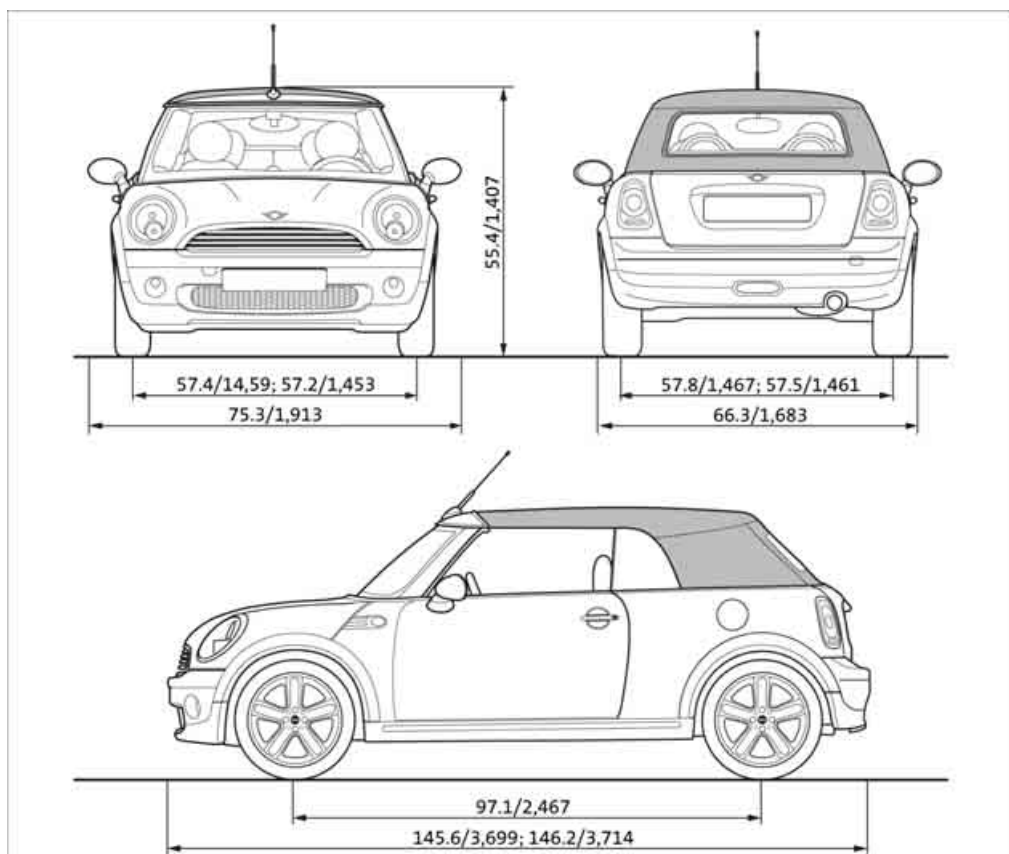

All dimensions in inches/mm. Minimum turning radius \varnothing : 35 ft 10 in/10.7 m.
 Information after the semicolon: different values for MINI Cooper S.

WEIGHTS

MINI

		Cooper	Cooper S	John Cooper Works
Curb weight, ready for travel, with all optional extras				
▷ Manual transmission	lbs/kg	2,568/1,165	2,679/1,215	2,701/1,225
▷ Automatic transmission	lbs/kg	2,646/1,200	2,723/1,235	–
Approved gross weight				
▷ Manual transmission	lbs/kg	3,384/1,535	3,494/1,585	3,516/1,595
▷ Automatic transmission	lbs/kg	3,461/1,570	3,538/1,605	–
Approved front axle load				
▷ Manual transmission	lbs/kg	1,830/830	1,918/870	1,918/870
▷ Automatic transmission	lbs/kg	1,907/865	1,962/890	–
Approved rear axle load	lbs/kg	1,664/755	1,664/755	1,675/760
Approved roof load capacity	lbs/kg	165/75	165/75	165/75
Cargo bay capacity	cu ft/	5.7 - 24.0/	5.7 - 24.0/	5.7 - 24.0/
	liters	160 - 680	160 - 680	160 - 680

AT A GLANCE

CONTROLS

DRIVING TIPS

MOBILITY

REFERENCE

MINI Convertible

		Cooper	Cooper S	John Cooper Works
Curb weight, ready for travel, with all optional extras				
▷ Manual transmission	lbs/kg	2,745/1,245	2,855/1,295	2,877/1,305
▷ Automatic transmission	lbs/kg	2,822/1,280	2,921/1,325	–
Approved gross weight				
▷ Manual transmission	lbs/kg	3,560/1,615	3,671/1,665	3,693/1,675
▷ Automatic transmission	lbs/kg	3,638/1,650	3,737/1,695	–
Approved front axle load				
▷ Manual transmission	lbs/kg	1,863/845	1,951/885	1,962/890
▷ Automatic transmission	lbs/kg	1,940/880	2,017/915	–
Approved rear axle load	lbs/kg	1,786/810	1,786/810	1,797/815
Cargo bay capacity	cu ft/ liters	6.0-23.3/ 170-660	6.0-23.3/ 170-660	6.0-23.3/ 170-660

Never exceed either the approved axle loads or the gross vehicle weight.

CAPACITIES

	US gal/US quarts	liters	Notes
Fuel tank	13.2/–	approx. 50	Fuel grade: page 103
including reserve of	2.1/–	approx. 8	
Window washer system incl. headlamp washer system	–/4.8	approx. 4.5	For more details: page 51

EVERYTHING FROM A TO Z

INDEX

A

Accessories, refer to Your individual vehicle [4](#)

Acknowledgment signals for locking/unlocking vehicle [21](#)

Activated-charcoal filter for automatic climate control [83](#)

Additives

- coolant [118](#)
- engine oil [118](#)

Adjusting temperature inside the car, refer to Air conditioner [80](#)

Adjusting temperature inside the car, refer to Automatic climate control [81](#)

Air conditioner [79](#)

Air conditioning mode

- air conditioner [80](#)
- automatic climate control [81](#)
- ventilation [83](#)

Air distribution

- automatic [82](#)
- individual [81](#)
- manual [81](#)

Air flow rate [80, 82](#)

- air conditioning system [80](#)
- automatic climate control [82](#)
- heating, ventilation [80](#)

Air outlets, refer to Air vents [79](#)

Air pressure, checking, refer to Tire inflation pressure [104](#)

Air recirculation, refer to Recirculated-air mode [80, 82](#)

Air supply

- air conditioner [80](#)
- automatic climate control [81](#)
- ventilation [83](#)

Air vents [79](#)

Airbags [71](#)

- sitting safely [35](#)
- warning lamp [73](#)

Airing, refer to Ventilation [83](#)

AKI, refer to Fuel grade [103](#)

Alarm system [25](#)

All-season tires, refer to Winter tires [115](#)

Always Open Timer [55](#)

Ambient air, refer to Recirculated-air mode [80, 82](#)

Ambient lighting [78](#)

Antenna, care [121](#)

Antifreeze

- coolant [118](#)
- washer fluid [51](#)

Antilock Brake System ABS [64](#)

Anti-theft alarm system, refer to Alarm system [25](#)

Anti-theft system [19](#)

Approved axle loads, refer to Weights [157](#)

Approved engine oils [118](#)

Approved gross vehicle weight, refer to Weights [157](#)

Armrest, refer to Center armrest [86](#)

Ashtray [88](#)

Assistant systems, refer to

- Dynamic Stability Control DSC [64](#)

Audio device, external [86](#)

AUTO program for automatic climate control [82](#)

Automatic

- air distribution [82](#)
- air flow rate [82](#)
- cruise control [51](#)
- headlamp control [74](#)

Automatic climate control [79](#)

- automatic air distribution [82](#)

Automatic transmission with Steptronic [46](#)

- interlock [46](#)
- overriding selector lever lock [48](#)
- shiftlock [46](#)
- sport program [47](#)

AUX-IN, refer to External audio device [86](#)

Average fuel consumption [54](#)

- setting the units [57](#)

Average speed [55](#)

Axle loads, refer to Weights [157](#)

B

Background lighting, refer to Ambient lighting [78](#)

Backrests, refer to Seats [35](#)

Backup lamps

- replacing bulb [128, 129](#)

Band-aids, refer to First aid pouch [136](#)

Bar, refer to Tow-starting, towing away [138](#)

Battery [134](#)

- charging [135](#)
- disposal [28, 135](#)
- jump-starting [136](#)
- temporary power failure [135](#)

Battery renewal

- remote control [28](#)

Being towed [138](#)

Belt tensioner, refer to Safety belts [38](#)

Belts, refer to Safety belts [38](#)

Beverage holders, refer to Cupholders [88](#)

Black ice, refer to Outside temperature warning [53](#)

Blower, refer to Air flow rate [80, 82](#)

Bottle holders, refer to
 Cupholders 88
Brake Assist 64
Brake fluid, refer to Service requirements 58
Brake lamps
 – replacing bulbs 129
Brake pads, breaking in 92
Brake rotors 93
 – brakes 92
 – breaking in 92
Brake system 92
 – breaking in 92
 – disc brakes 93
 – MINI Maintenance System 119
Brakes
 – ABS 64
 – breaking in 92
 – MINI Maintenance System 119
 – parking brake 45
 – service requirements 58
Brakes, refer to Braking safely 93
Breakdown service, refer to Roadside Assistance 136
Break-in period 92
Breaking in the clutch 92
Bulb changing, refer to Lamps and bulbs 125
Button for starting the engine 44
Buttons on the steering wheel 11

C

California Proposition 65 warning 5
Can holders, refer to
 Cupholders 88
Capacities 158
Car battery, refer to Vehicle battery 134
Car care 121
Car key, refer to Keys/remote controls 18
Car phone
 – installation location, refer to Center armrest 86
 – refer to separate Owner's Manual
Car wash, care 121
Car washes 121
Care 121
 – car washes 121
 – car-care products 121
 – CD/DVD drives 124
 – external 121
 – high-pressure washers 122
 – internal 123
 – leather 123
 – manual washing 122
 – upholstery and fabrics 123
 – windows 122
 – wiper blades 122
Cargo area
 – capacity 157
Cargo bay 94
 – Comfort Access 27
 – cover 94
 – lamp 77
 – opening from outside 24
Cargo bay, expanding 94
Cargo bay lamp 77
Cargo bay lid, refer to Liftgate 24
Cargo loading 95
 – securing cargo 96
 – stowing cargo 96
 – vehicle 94
Cargo, securing 96
Carpets, care 123
Catalytic converter, refer to Hot exhaust system 92
Center armrest 86
Center brake lamp 129
Center console, refer to Around the center console 14
Central locking system 19
 – Comfort Access 26
 – from inside 23
 – from outside 19
Changing bulbs 125
Changing wheels 132
Chassis number, refer to Engine compartment 117
Check Control 61
Child restraint systems 41
Child seats 41
Child-restraint fixing system LATCH 42
Chock, folding
 – space-saver spare tire 132
Chrome parts, care 123
Chrome parts, refer to Care 121
Cigarette lighter 88
Cleaning headlamps 50
 – washer fluid 51
Clock 53
 – 12h/24h mode 57
 – setting time 60
Closing
 – from inside 23
 – from outside 19
Clothes hooks 87
Cockpit 10
Cold start, refer to Starting the engine 45
Comfort Access 26
 – replacing the battery 28
 – what to observe before entering a car wash 27
Comfort area, refer to Around the center console 14
Control panel for remote control, refer to Ignition lock 44
Computer 54
Condensation, refer to When the vehicle is parked 93
Condition Based Service CBS 119
Configuring settings, refer to Personal Profile 18
Connecting vacuum cleaner, refer to Connecting electrical appliances 88
Consumption, refer to Average fuel consumption 54
Control Display
 – settings 56
Controls and displays 10

Convenient access, refer to
 Comfort Access **26**
 Convenient operation
 – convertible top **22**
 – windows **20**
 Convenient start, refer to
 Starting the engine **45**
 Convertible top **30**
 Coolant **118**
 – checking level **118**
 – filling **118**
 Coolant temperature **53**
 Cooling fluid, refer to
 Coolant **118**
 Cooling, maximum **82**
 Copyright **2**
 Cruising range **54**
 Cupholders **88**
 Curb weight, refer to
 Weights **157**
 Current fuel consumption **55**

D

Dashboard instruments, refer to
 Displays **12**
 Dashboard lighting, refer to
 Instrument lighting **77**
 Dashboard, refer to Cockpit **10**
 Data **154**
 – capacities **158**
 – dimensions **155**
 – engine **154**
 – weights **157**
 Data memory **120**
 Date
 – setting **61**
 Daytime running lights **75**
 DBC Dynamic Brake Control,
 refer to Brake Assist **64**
 Deactivating front passenger
 airbags **72**
 Deadlocking, refer to
 Locking **20**
 Defect
 – door lock **22**
 – fuel filler flap **102**
 Defogging windows **81, 83**

Defrost position, refer to
 Defrosting windows **81, 83**
 Defrosting windows **81, 83**
 Defrosting windows and
 removing condensation
 – air conditioner **81**
 – automatic climate control **83**
 Defrosting windshield, refer to
 Defrosting windows **81, 83**
 Differential, breaking in **92**
 Digital clock **53**
 Dimensions **155**
 Dipstick, engine oil **117**
 Directional indicators, refer to
 Turn signals **48**
 Displacement, refer to Engine
 data **154**
 Display lighting, refer to
 Instrument lighting **77**
 Displays **12**
 – instrument combination **12**
 Displays and controls **10**
 Displays, care **124**
 Disposal
 – of coolant **118**
 – remote control battery **28**
 – vehicle battery **135**
 Distance remaining to service,
 refer to Service
 requirements **58**
 Distance warning, refer to Park
 Distance Control PDC **63**
 Door key, refer to Integrated
 key/remote control **18**
 Door lock **22**
 Door lock, confirmation
 signals **21**
 Doors, manual operation **22**
 DOT Quality Grades **112**
 Drinks holders, refer to
 Cupholders **88**
 Drive-off assistant, refer to Hill
 Assist **65**
 Driving dynamics control, refer
 to Sport button **65**
 Driving lamps, refer to Parking
 lamps/low beams **74**
 Driving notes **92**

Driving off on inclines, refer to
 Hill Assist **65**
 Driving stability control
 systems **63**
 Driving through water **93**
 Driving tips, refer to Driving
 notes **92**
 Dry air, refer to Cooling
 function **83**
 DTC Dynamic Traction Control
 DTC **64**
 Dynamic Brake Control DBC,
 refer to Brake Assist **64**
 Dynamic Stability Control
 DSC **64**
 Dynamic Traction Control **64**

E

Electric power windows
 – initializing **29**
 Electrical malfunction
 – convertible top **32**
 – door lock **22**
 – fuel filler flap **102**
 – trunk lid **24**
 Electronic brake-force
 distribution **64**
 Electronic Stability Program
 ESP, refer to Dynamic
 Stability Control DSC **64**
 Emergency operation, refer to
 Manual operation
 – convertible top **32**
 – door lock **22**
 – fuel filler flap **102**
 – transmission lock, automatic
 transmission **48**
 – trunk lid **24**
 Emergency services, refer to
 Roadside Assistance **136**

Engine
– breaking in 92
– data 154
– overheated, refer to Coolant temperature 53
– speed 154
– starting 45
– starting, Comfort Access 26
– switching off 45
Engine compartment 117
Engine coolant, refer to Coolant 118
Engine oil
– adding 118
– additives, refer to Approved engine oils 118
– alternative oil types 118
– approved engine oils 118
– capacity 118
– checking level 117
– dipstick 117
– intervals between changes, refer to Service requirements 58
– MINI Maintenance System 119
Engine oil level, checking 117
Engine output, refer to Engine data 154
Engine starting, refer to Starting the engine 45
Error messages, refer to Check Control 61
ESP Electronic Stability Program, refer to Dynamic Stability Control DSC 64
Exhaust system, refer to Hot exhaust system 92
Exterior mirrors 39
– adjusting 39
– automatic heating 39
– folding in and out 39
External audio device 86
Eyes
– for tow-starting and towing away 138
– for tying down loads 96

F

Failure messages, refer to Check Control 61
Failure of an electrical consumer 135
Fastening safety belts, refer to Safety belts 38
Filter
– microfilter for air conditioner 81
– microfilter/activated-charcoal filter for automatic climate control 83
Fine wood, care 124
First aid pouch 136
Fixture for remote control, refer to Ignition lock 44
Flash when locking/unlocking 21
Flat tire
– run-flat tires 114
– Tire Pressure Monitor TPM 68
Flat Tire Monitor FTM 66
– indicating a flat tire 67
– initializing the system 66
– snow chains 66
– system limits 66
Flat tires, refer to Tire condition 113
Floor mats, care 123
Fog lamps
– replacing bulb 127, 129
Folding rear seat backrest 94
Folding roof, refer to Convertible top with integrated sliding sunroof 30
Footbrake, refer to Braking safely 93
Footwell lamps 77
For your own safety 5
Front airbags 71
Front fog lamps 77
– indicator lamp 140
– replacing bulb 127
Front seat adjustment 35
Frost on windows, refer to Defrosting windows 81, 83

FTM, refer to Flat Tire Monitor 66
Fuel 103
– gauge 54
– high-quality brands 103
– quality 103
– specifications 103
– tank capacity 158
Fuel clock, refer to Fuel gauge 54
Fuel consumption display
– average fuel consumption 54
Fuel display, refer to Fuel gauge 54
Fuel filler flap 102
– releasing in the event of electrical malfunction 102
Fuses 135

G

Garage door opener, refer to Integrated universal remote control 84
Gasoline
– refer to Average fuel consumption 54
Gasoline display, refer to Fuel gauge 54
Gasoline, refer to Required fuel 103
Gear indicator
– automatic transmission with Steptronic 46
Gear shifting
– automatic transmission 46
– manual transmission 46
Gearshift lever
– automatic transmission with Steptronic 46
– manual transmission 46
General driving notes 92
Glass sunroof, electric 28
– convenient operation 20, 22
– opening, closing 28
– raising 28
– remote control 20
Glove compartment 85
Grills, refer to Air vents 79

Gross vehicle weight, refer to Weights [157](#)

H

Halogen lamps

– replacing bulb [126](#)

Handbrake, refer to Parking brake [45](#)

Hands-free system [14](#)

Hazard warning flashers [14](#)

Head airbags [71](#)

Head restraints [37](#)

– sitting safely [35](#)

Headlamp control, automatic [74](#)

Headlamp flasher [48](#)

– indicator lamp [11](#), [140](#)

Headlamps

– replacing bulb [126](#)

Headlamps, care [122](#)

Headlight glass lens [126](#)

Heated

– mirrors [39](#)

– rear window [80](#), [82](#)

– seats [38](#)

Heating [79](#)

– mirrors [39](#)

– rear window [80](#), [82](#)

– seats [38](#)

Heavy loads, refer to Stowing cargo [96](#)

Height adjustment

– seats [36](#)

– steering wheel [40](#)

Height, refer to

Dimensions [155](#)

High beams [76](#)

– headlamp flasher [76](#)

– indicator lamp [140](#)

– replacing bulb [126](#)

High water, refer to Driving through water [93](#)

Hill Assist [65](#)

Hills [93](#)

Holders for cups [88](#)

Homepage [4](#)

Hood [116](#)

Horn [10](#)

Hot exhaust system [92](#)

Hydroplaning [92](#)

I

Ice warning [53](#)

Ignition [44](#)

– switched off [44](#)

– switched on [44](#)

Ignition key position 1, refer to Radio readiness [44](#)

Ignition key position 2, refer to Ignition on [44](#)

Ignition key, refer to Integrated key/remote control [18](#)

Ignition lock [44](#)

Imprint [2](#)

Indicator and warning lamps [13](#), [140](#)

– Tire Pressure Monitor TPM [69](#)

Indicator lighting, refer to Instrument lighting [77](#)

Individual air distribution [81](#)

Individual settings, refer to

Personal Profile [18](#)

Inflation pressure monitoring, refer to Tire Pressure Monitor TPM [68](#)

Initializing

– Flat Tire Monitor FTM [66](#)

– glass sunroof, electric [29](#)

Instrument cluster, refer to

Displays [12](#)

Instrument lighting [77](#)

Instrument panel, refer to

Cockpit [10](#)

Instrument panel, refer to

Displays [12](#)

Integrated key [18](#)

Integrated universal remote control [84](#)

Interior lamps [77](#)

– remote control [21](#)

Interior rearview mirror [39](#)

– automatic dimming feature [40](#)

Interlock [46](#)

Intermittent mode of the wipers [49](#)

Internet page [4](#)

J

Jacking points [134](#)

Jets, refer to Window washer nozzles [51](#)

Jumpering, refer to Jump-starting [136](#)

Jump-starting [136](#)

K

Key Memory, refer to Personal Profile [18](#)

Key, refer to Keys/remote controls [18](#)

Keyless opening and closing, refer to Comfort Access [26](#)

Keyless-Go, refer to Comfort Access [26](#)

Kickdown [47](#)

– automatic transmission with Steptronic [47](#)

Knock control [103](#)

L

Lamps and bulbs, replacing bulbs [125](#)

Lamps, refer to Parking lamps/Low beams [74](#)

Lashing eyes, refer to Securing cargo [96](#)

LATCH child-restraint fixing system [42](#)

Leather care [123](#)

LEDs light-emitting diodes [126](#)

Length, refer to

Dimensions [155](#)

License plate lamp

– bulb replacement [129](#)

Liftgate [24](#)
– Comfort Access [27](#)
– opening from outside [24](#)
– opening/closing [24](#)
– unlocking with remote control [21](#)

Light switch [74](#)

Light-alloy wheels, care [123](#)

Light-emitting diodes
LEDs [126](#)

Lighter [88](#)
– socket [88](#)

Lighting
– lamps and bulbs [125](#)
– of the instruments [77](#)
– of vehicle, refer to Lamps [74](#)

Limit [151](#)

Load [95](#)

Load securing equipment,
refer to Securing cargo [96](#)

Lock buttons of doors, refer to
Locking [23](#)

Locking
– adjusting confirmation signal [21](#)
– from inside [23](#)
– from outside [20](#)
– without remote control, refer to Comfort Access [26](#)

Locking and unlocking doors
– confirmation signals [21](#)
– from inside [23](#)
– from outside [19](#)

Low beams [74](#)
– automatic [74](#)
– replacing bulb [126](#)

Lower back support, refer to
Lumbar support [36](#)

Luggage compartment
– emergency operation, refer to Manual release [24](#)
– increasing the capacity [95](#)
– opening from the inside [24](#)

Luggage compartment lid
– emergency operation, refer to Manual release [24](#)

Luggage compartment lid,
refer to Liftgate [24](#)

Luggage compartment, refer to Cargo bay [24](#)

Luggage rack, refer to Roof-mounted luggage rack [97](#)

Lumbar support [36](#)

M

M+S tires, refer to Winter tires [115](#)

Maintenance, refer to Service Booklet

Maintenance system [119](#)

Malfunction
– convertible top [32](#)
– trunk lid [24](#)

Malfunction warnings, refer to Check Control [61](#)

Manual air distribution [81](#)

Manual mode
– automatic transmission with Steptronic [47](#)

Manual operation
– door lock [22](#)
– fuel filler flap [102](#)
– power convertible top [32](#)
– transmission lock, automatic transmission [48](#)
– trunk lid [24](#)

Manual transmission [46](#)

Manual washing [122](#)

Master key, refer to Integrated key/remote control [18](#)

Maximum cooling [82](#)

Maximum speed
– with winter tires [115](#)

Medical assistance, refer to First aid pouch [136](#)

Microfilter
– for air conditioner [81](#)
– for automatic climate control [83](#)

– MINI Maintenance System [119](#)

Microfilter/activated-charcoal filter
– MINI Maintenance System [119](#)

Microphone for telephone [14](#)

MINI Internet page [4](#)

MINI Maintenance System [119](#)

Mirror dimming feature [40](#)

Mirrors [39](#)
– exterior mirrors [39](#)
– heating [39](#)
– interior rearview mirror [39](#)

Mobile phone
– installation location, refer to Center armrest [86](#)
– refer to separate Owner's Manual

Mobile phone, installation location, refer to Center armrest [86](#)

Mobile phone, refer to the separate Owner's Manual

Mobility System [130](#)

Modifications, technical, refer to For your own safety [5](#)

Monitoring system for tire pressures, refer to Flat Tire Monitor [66](#)

Multifunction switch
– refer to Turn signals/headlamp flasher [48](#)
– refer to Wiper system [49](#)

Multifunctional steering wheel, refer to Buttons on the steering wheel [11](#)

N

Neck support, refer to Head restraints [37](#)

Nets, refer to Storage compartments [87](#)

New tires [114](#)

Number of cylinders, refer to Engine data [154](#)

Number of safety belts [35](#)

Nylon rope, refer to Tow rope [138](#)

O

OBD socket, refer to Socket for Onboard Diagnosis [119](#)

Octane ratings, refer to Fuel specifications **103**
 Odometer **53**
 Oil consumption **117**
 Oil level **117**
 Oil, refer to Engine oil **117**
 Oil types **118**
 Old batteries, refer to Disposal **135**
 Onboard vehicle tool kit **125**
 Opening and closing
 – Comfort Access **26**
 – from inside **23**
 – from outside **19**
 – using the door lock **22**
 – using the remote control **19**
 Opening and unlocking
 – from inside **23**
 Outlets
 – refer to Ventilation **83**
 Outlets, refer to Air vents **79**
 Output, refer to Engine data **154**
 Outside temperature display **53**
 – change units of measure **57**
 – in the onboard computer **57**
 Outside-air mode
 – automatic climate control **82**
 Overheated engine, refer to Coolant temperature **53**

P

Paintwork, care **122**
 Park Distance Control PDC **63**
 Parking
 – vehicle **45**
 Parking aid, refer to Park Distance Control PDC **63**
 Parking brake **45**
 Parking lamps, replacing bulb **127**
 Parking lamps/low beams **74**
 Parts and accessories, refer to Your individual vehicle **4**
 Pathway lighting **74**
 Personal Profile **18**

Pinch protection system
 – windows **30**
 Plastic parts, care **124**
 Pollen
 – refer to Microfilter for air conditioner **81**
 – refer to Microfilter/activated-charcoal filter for automatic climate control **83**
 Power convertible top **30**
 Power failure **135**
 Power windows **29**
 Power windows, refer to Windows **29**
 Pressure monitoring of tires, refer to Tire Pressure Monitor TPM **68**
 Pressure monitoring, tires **66**
 – Flat Tire Monitor **66**
 Pressure, tires **104**
 Protective function, refer to Pinch protection system
 – windows **30**
 Puncture
 – Flat Tire Monitor **66**

R

Radio key, refer to Integrated key/remote control **18**
 Radio position, refer to Radio readiness **44**
 Radio readiness **44**
 – switched off **44**
 – switched on **44**
 Rain sensor **49**
 Range, refer to Cruising range **54**
 Reading lamps **78**
 Rear fog lamp **77**
 – indicator lamp **140**
 – replacing bulb **129**
 Rear lamps
 – bulb replacement **129**
 Rear lamps, refer to Tail lamps **128**
 Rear luggage rack **97**
 Rear seat backrest, folding **94**

Rear seats
 – folding the backrests **94**
 Rear window defroster **80, 82**
 Rearview mirror, refer to Mirrors **39**
 Recirculated-air mode **80, 82**
 Recirculation of air, refer to Recirculated-air mode **80, 82**
 Reclining seat, refer to Backrest **36**
 Refueling **102**
 Releasing
 – hood **116**
 Remote control **18**
 – battery renewal **28**
 – Comfort Access **26**
 – garage door opener **84**
 – liftgate **21**
 – malfunctions **22, 27**
 – service data **119**
 Replacement remote control **18**
 Replacing bulbs, refer to Lamps and bulbs **125**
 Replacing tires, refer to New wheels and tires **114**
 Reporting safety defects **6**
 Reserve warning, refer to Fuel gauge **54**
 Reservoir for washer systems **51**
 Restraint systems
 – for children **41**
 – refer to Safety belts **38**
 Reverse gear
 – automatic transmission with Steptronic **47**
 – manual transmission **46**
 Roadside Assistance **136**
 Roadside parking lamps **76**
 – replacing bulb **127**
 Roadworthiness test, refer to Service requirements **58**
 Roof load capacity **157**
 Roof-mounted luggage rack **97**

Rope, refer to Tow-starting, towing away **138**
RSC Run-flat System
Component, refer to Run-flat tires **114**
Rubber parts, care **123**
Run-flat System Component
RSC, refer to Run-flat tires **114**
Run-flat tires **114**
– flat tire **67**
– tire inflation pressure **104**
– tire replacement **114**
– winter tires **115**

S

Safety belt
– number **35**
Safety Belt Reminder **39**
Safety belts **38**
– damage **39**
– indicator lamp **39**
– reminder **39**
– sitting safely **35**
Safety belts, care **124**
Safety systems
– airbags **71**
– Antilock Brake System
ABS **64**
– Dynamic Stability Control
DSC **64**
– safety belts **38**
Safety tires, refer to Run-flat tires **114**
Screw thread for tow fitting **138**
Seat adjustment
– mechanical **36**
Seats **35**
– adjusting the seats **36**
– heating **38**
– sitting safely **35**
Securing the vehicle
– from inside **23**
– from outside **19**

Selector lever
– automatic transmission with
Steptronic **46**
Selector lever lock
– automatic transmission with
Steptronic, refer to
Shiftlock **46**
– overriding manually **48**
Selector lever positions
– automatic transmission with
Steptronic **46**
Service car, refer to Roadside
Assistance **136**
Service data in the remote
control **119**
Service Interval Display, refer
to Condition Based Service
CBS **119**
Service, refer to Roadside
Assistance **136**
Service requirement display,
refer to Condition Based
Service CBS **119**
Service requirements **58**
Settings
– clock, 12h/24h mode **57**
Shifting gears
– automatic transmission with
Steptronic **47**
– manual transmission **46**
Shiftlock
– automatic transmission, refer
to Changing selector lever
positions **46**
Side airbags **71**
Side turn signal indicator
– replacing bulb **128**
Side windows, refer to
Windows **29**
Signal horn, refer to Horn **10**
Sitting safely **35**
– airbags **35**
– safety belts **35**
– with head restraint **35**
Size, refer to Dimensions **155**
Sliding/tilt sunroof
– refer to Glass sunroof,
electric **28**

Slipstream deflector, refer to
Wind deflector **33**
Slot for remote control **44**
Smokers' package, refer to
Ashtray **88**
Snap-in adapter, refer to
Center armrest storage
compartment **86**
Snow chains **115**
Socket for Onboard Diagnosis
OBD **119**
Socket, refer to Connecting
electrical appliances **88**
Space-saver spare tire
– changing tires **132**
– inflation pressure **104**
Spare wheel, refer to Space-
saver spare tire **132**
Special oils, refer to Approved
engine oils **118**
Speed **154**
– with winter tires **115**
Speedometer **12**
Split rear backrest, refer to
Through-loading system **95**
Split rear seat backrest, refer to
Expanding the cargo bay **94**
Sport button **65**
Stability control, refer to
Driving stability control
systems **63**
Start/stop button **44**
– starting the engine **45**
– switching off the engine **45**
Starting assistance, refer to
Jump-starting **136**
Starting, refer to Starting the
engine **45**
Starting the engine
– start/stop button **44**
Start-off assistance, refer to
– DSC **64**
– Hill Assist **65**
Status of this Owner's Manual
at time of printing **4**

Steering wheel **40**
 – adjustment **40**
 – buttons on steering wheel **11**
 – lock **44**
 – shift paddles **47**
 Steptronic, refer to Automatic transmission with Steptronic **46**
 Storage area
 – cargo bay **94**
 Storage compartment, front passenger side **87**
 Storage compartments **87**
 Storage space
 – storage compartments **87**
 Storage space, refer to
 – Luggage compartment in the MINI Convertible **94**
 Storing the vehicle **124**
 Storing tires **115**
 Stowage, refer to Storage compartments **87**
 Summer tires, refer to Wheels and tires **104**
 Switches, refer to Cockpit **10**
 Switching off
 – engine **45**
 Switching off the engine
 – start/stop button **44**
 Switching the cooling function on and off **83**
 Symbols **4**

T

Tachometer **53**
 Tail lamp, refer to Tail lamps **128**
 – replacing bulb **128**
 Tail lamps **128**
 Tank volume, refer to Capacities **158**
 Technical data **154**
 Technical modifications **5**
 Telephone
 – installation location, refer to Center armrest **86**
 – refer to separate Owner's Manual

Telephone call, refer to the Owner's Manual for the telephone
 Temperature display
 – ice warning **53**
 – outside temperature **53**
 – setting the units **57**
 Temperature of coolant, refer to Coolant temperature **53**
 Temperature setting
 – air conditioner **80**
 – automatic climate control **82**
 Tempomat, refer to Cruise control **51**
 Tensioning straps, refer to Securing cargo **96**
 The individual vehicle **4**
 Third brake lamp, refer to Center brake lamp **129**
 Three-point safety belt **38**
 Through-loading system **95**
 Tightening the lug bolts
 – keys **132**
 – torque **134**
 Tightening torque, refer to Tightening lug bolts **134**
 Tire change set
 – space-saver spare tire **132**
 Tire failure
 – Flat Tire Monitor **67**
 – indicator/warning lamp **67**
 – MINI Mobility System **130**
 – run-flat tires **67**
 – space-saver spare tire **132**
 – Tire Pressure Monitor **68**
 Tire inflation pressure **104**
 – loss **67**
 – space-saver spare tire **104**
 Tire Pressure Monitor TPM **68**
 – limitations of system **68**
 – resetting system **68**
 – warning lamp **69**
 Tire pressure monitoring, refer to Flat Tire Monitor **66**
 Tire Quality Grading **112**

Tires
 – age **113**
 – breaking in **92**
 – changing, refer to Changing wheels **132**
 – condition **113**
 – damage **113**
 – inflation pressure **104**
 – inflation pressure loss **69**
 – minimum tread depth **113**
 – new tires **114**
 – pressure monitoring, refer to Flat Tire Monitor **66**
 – pressure monitoring, refer to Tire Pressure Monitor TPM **68**
 – puncture **67**
 – size **112**
 – wear indicators, refer to Minimum tread depth **113**
 – winter tires **115**
 – with emergency operation properties **114**
 Tires with emergency operation properties, refer to Run-flat tires **114**
 Tires with safety features, refer to Run-flat tires **114**
 Tools, refer to Onboard vehicle tool kit **125**
 Torque **154**
 – lug bolts **134**
 Tow bar **138**
 Tow fitting **138**
 – screw thread **138**
 Tow fittings for tow-starting and towing away **138**
 Tow rope **138**
 Towing **137**
 – car with automatic transmission **138**
 – methods **138**
 Tow-rope starting **137**
 TPM, refer to Tire Pressure Monitor **68**
 Track width, refer to Dimension **155**

Traction control, refer to
– Dynamic Stability Control DSC 64

Trailer operation
– trailer loads and gross vehicle weight 157

Transmission
– automatic transmission with Steptronic 46
– manual transmission 46
– overriding selector lever lock for automatic transmission with Steptronic 48

Transport securing devices, refer to Securing cargo 96

Transporting children safely 41

Tread depth, refer to Minimum tire tread 113

Trip odometer 53

Trip-distance counter, refer to Trip odometer 53

Triple turn signal activation 48

Trunk lid
– emergency operation 24
– releasing manually 24

Trunk, refer to Luggage compartment in the MINI Convertible 94

Turn signal indicator 48
– front, replacing bulb 127
– indicator lamp 12
– rear, replacing bulb 128
– side, replacing bulb 128

Turning circle, refer to Dimensions 155

Tying down loads, refer to Cargo loading 96

U

Uniform Tire Quality Grading UTQR 112

Units
– average fuel consumption 57
– temperature 57

Universal garage door opener, refer to Integrated universal remote control 84

Universal remote control 84

Unlatching, refer to Unlocking 27

Unlocking
– from inside 23
– from outside 19
– liftgate 27
– without remote control, refer to Comfort Access 26

Upholstery, care 123

USB audio interface 86

V

Valve
– dust cap 133

Vehicle
– battery 134
– breaking in 92
– cargo loading 94
– dimensions 155
– Identification Number, refer to Engine compartment 117
– parking 45
– storage 124
– weight 157

Vehicle jack 132
– jacking points 134

Ventilation
– air conditioner 83

Vents, refer to Air vents 79

Vents, refer to Ventilation 83

Volume of cargo area 157

W

Warning and indicator lamps 13, 140

Warning messages, refer to Check Control 61

Warning triangle 136

Washer fluid 51
– capacity of reservoir 51

Washer fluid reservoir 51

Waste tray, refer to Ashtray 88

Water on roads, refer to Driving through water 93

Waterfall lighting, refer to Ambient lighting 78

Wear indicators in tires, refer to Minimum tread depth 113

Weights 157

Welcome lamps 74

Wheel stud wrench
– space-saver spare tire 132

Wheelbase, refer to Dimensions 155

Wheels and tires 104

Wheels, new 114

Width, refer to Dimensions 155

Wind deflector 33

Window washer, refer to Washer fluid 51

Window washer reservoir, refer to Washer fluid
– volume, refer to Capacities 158

Window washer system 49
– washer fluid 51
– washer jets 51

Windows 29
– closing 29
– convenient operation 20
– opening 29
– pinch protection system 30

Windshield
– cleaning 50
– defrosting and removing condensation 81, 83

Windshield wiper blades, changing 125

Windshield wipers, refer to Wiper system 49

Winter tires 115
– storage 115

Wiper blade replacement 125

Wiper system 49

Work in the engine compartment 116

Wrench/screwdriver, refer to Onboard vehicle tool kit 125

X

Xenon lamps
– replacing bulb 126



DRIVE ME.